

### Ultrasonic heat and cooling energy meters

UH50..



#### **Ultrasonic heating and cooling energy meters to measure flow and energy in hydronic heating or refrigerant circuits.**

- Available as heat, cooling energy, or combined heat/cooling energy meters
- Separate acquisition of heating or cooling energy by the combined heat/cooling energy meters, with automatic changeover
- Non-wearing due to non-moving parts
- Approved in accordance with EN 1434 and MID accuracy class 2
- Any mounting position (horizontal or vertical), in return
- Measuring range of flow 1:100 as per EN 1434, 1:1,000 total range
- Choice of communication modules and power supplies
- Upstream or downstream setting paths are not required
- Optical interface as per EN 62056-21
- Self-diagnostics

## Use

The UH50.. heating and cooling energy meter physically acquires energy consumption. The amount of heating or cooling energy is acquired separately and can be read out either on site or from a remote location. The device consists of a flow measuring section and processor unit. The processor unit can be equipped with different sensors, different types of power supply and communication modules. The UH50.. is used to measure the consumption of heat in district heating systems and blocks of flats. It is also suited to measure the consumption of cooling energy (cooling energy only or in combination with thermal energy), or volume flow in hydronic systems.

### Restrictions

Do not use the UH50.. to measure potable water.

Also, the product is not suited for use in systems operating on water-glycol mixtures.

## Functions

### Ultrasonic measuring principle

The flow is acquired based on the non-wear ultrasonic measuring principle, which requires no moving parts.

The quantity of energy supplied to the consumer by the medium during a certain period of time is proportional to the temperature differential of flow and return and the volume flow passing through the meter.

The **water volume** is measured in the measuring tube by ultrasonic pulses which are transmitted in the direction of flow and against the direction of flow. Downstream, the time required by the pulses to travel from the transmitter to the receiver is reduced, upstream it is increased. The water volume is calculated based on the difference in runtime.

The **flow and return temperatures** are determined using platinum resistors.

The water volume as well as the temperature difference between the warmer and cooler side is multiplied using a heat coefficient and the product is integrated. The result, which is the consumed **heating or cooling energy quantity**, is registered and displayed in the physical units **kWh/MWh** or **MJ/GJ**; the volume in **m<sup>3</sup>**.

### Processor unit

The same standard electronics unit with a built-in service unit is used for all flow rates.

### Optical communication interface

The meter is equipped with an optical communication interface, enabling the device to be read and configured on site with the help of the WZR-OP-USB optical read head and the UltraAssist software.

### Self-diagnostics

The meter continuously performs self-diagnostics, allowing it to detect a number of mounting or device errors and to display them.

**Metering accuracy as per EN 1434**

The diagram below shows the typical metering accuracy of the UH50..., compared to the error limits per EN 1434, class 2.

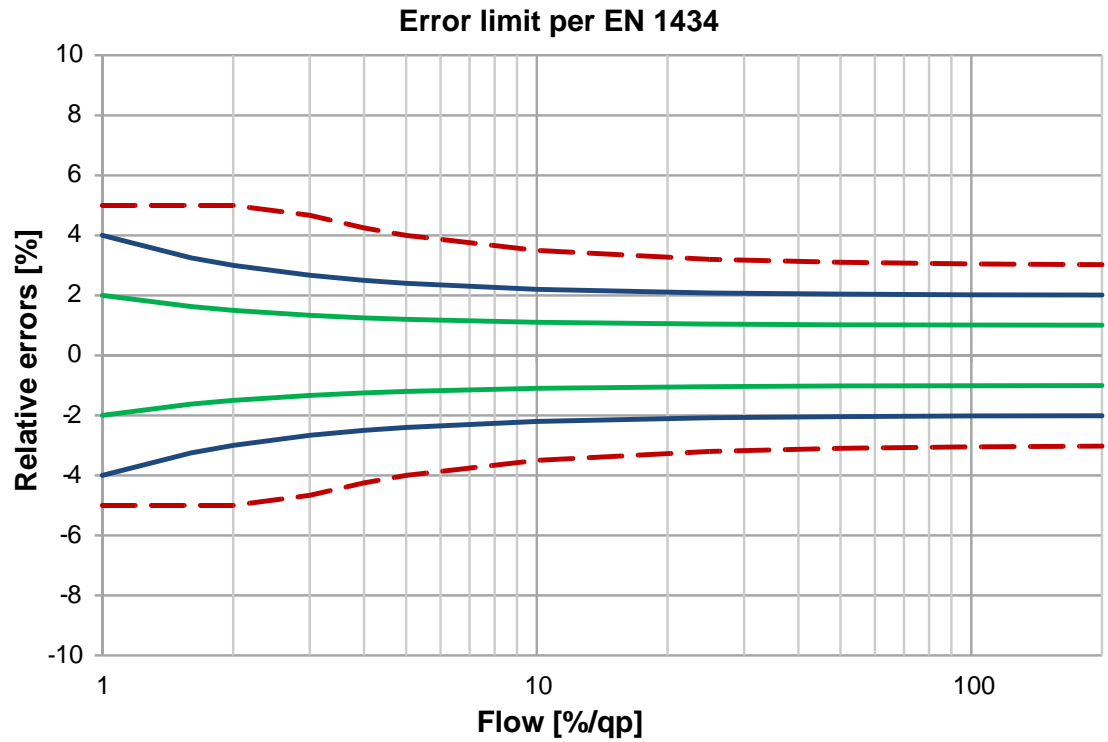

Key:

- - - EN 1434, class 3
- EN 1434, class 2
- UH50.. typical (EN 1434, 1/2 class 2)

The pressure loss in a flow sensor is indicated as nominal flow  $q_p$ .

Actual pressure loss at the indicated flow can be calculated using the  $K_v$  value, which indicates flow at 1 bar differential pressure:

$$\Delta p = 1 \text{ bar} \times \left(\frac{Q}{K_v}\right)^2$$

$\Delta p$  = Pressure loss in bar

$Q$  = Flow in  $\text{m}^3 / \text{h}$

$K_v$  =  $K_v$  – Value at  $\Delta p = 1$  bar

Nominal flow $q_p$ $\text{m}^3/\text{h}$	Mounting length mm	Connecting thread	Pressure loss at $q_p$ mbar	$K_v$ value at $\Delta p = 1$ bar $\text{m}^3/\text{h}$	Curve in the diagram
0.6	110, 190	G 3/4, G 1, DN20	150	1.5	A
1.5	130, 190	G 1, DN20	160	3.8	B
1.5	110	G 3/4	150	3.9	C
2.5	190	G 1, DN20	210	5.3	D
2.5	130	G 1	200	5.6	E
3.5	260	G1 1/4, DN25	55	15	F

Nominal flow $q_p$ $m^3/h$	Mounting length mm	Connecting thread	Pressure loss at $q_p$ mbar	Kv value at $\Delta p = 1$ bar $m^3/h$	Curve in the diagram
6	15	G1¼	190	14	G
6	260	G1¼, DN25	140	16	H
10	200, 300	G 2, DN40	130	28	I
10	300	G 2	110	30	J
15	270	DN50	110	45	K
15	200	DN50	95	49	L
25	300	DN65	105	77	M
40	300	DN80	160	100	N
60	360	DN100	115	177	O
150	500	DN150	120	433	P

The value can also be read graphically using the diagram as an alternative.

#### Pressure drop characteristic

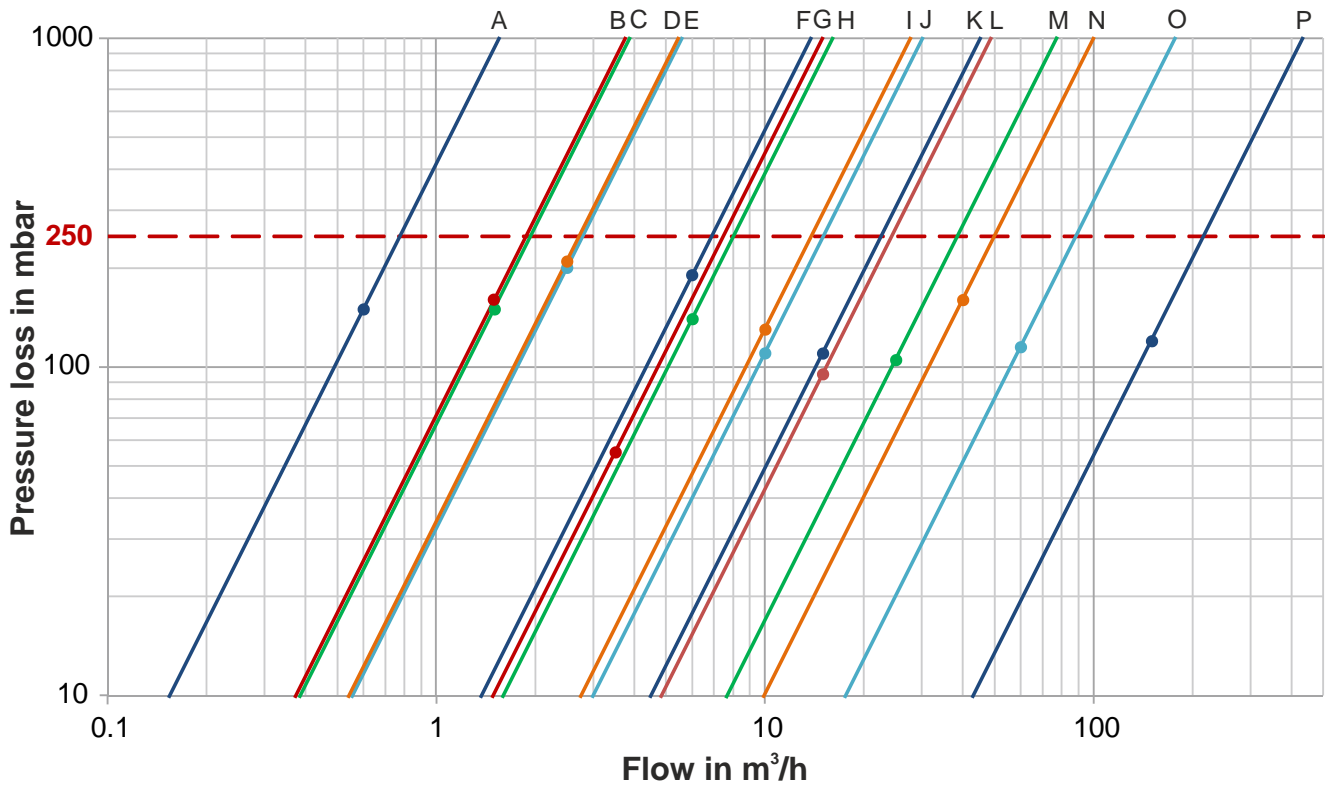

## Display

The meter displays current readings in kWh, MWh, MJ or GJ.

You can only select between kWh or MWh and MJ or GJ on the meter.

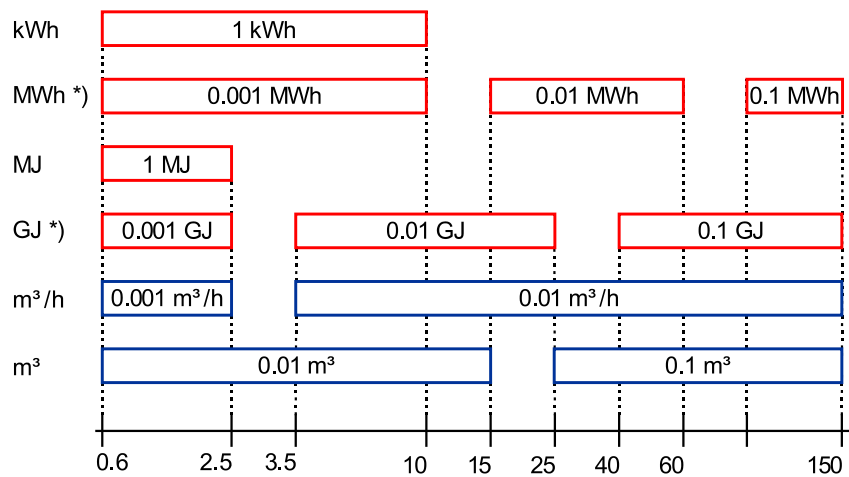

\*) Decimal places "flashing", "static", or "suppressed"

The decimal places of displayed values are rounded off to avoid errors.

Calibrated values are identified by a star symbol.

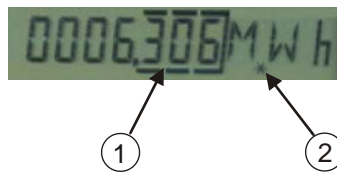

- 1 Decimal places outlined      2 Calibrated value

The number of decimal places of a value depends on the selected measuring path and the selected unit.

The meter's displays are arranged in 5 loops:

- 1 user loop
- 4 service loops

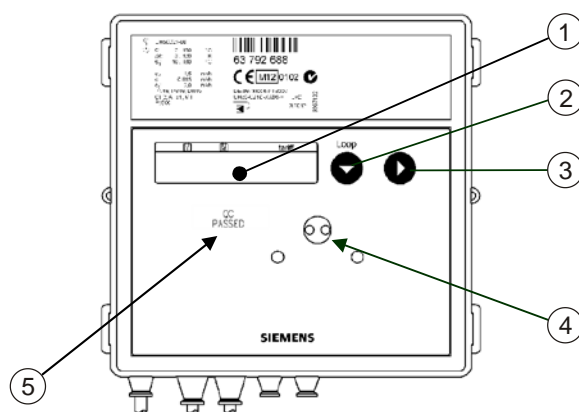

- 1 Display      2 Button 1  
 3 Button 2      4 Optical interface  
 5 Calibration seal

A short press on button 1 enables selection of the required loop. The user loop reappears after the last loop. Press button 2 to read the value on the respective loop. The first value reappears after the last loop.

<b>!</b>	<b>NOTICE</b>
	The range of display and the displayed data may deviate from this description and certain button functions may be disabled, depending on the parameter settings on the meter.

**User loop  
LOOP 0**

F -----	Error message with error code number (only in case of error)
-- 1234567 kWh	Accumulated energy with tariff state
T' 1234567 kWh	Tariff register 1 (optional)
1234567 m <sup>3</sup>	Accumulated volume
8888888 kWh	Segment test

**Service loop  
LOOP 1**

1234 m/h	Current flow rate
90.4 kW	Current power
TV 9.6 °C	TF: Current temperature on the heat side
TR 56.2 °C	TR: Current temperature on the cold side; at 2-second intervals
Ocd 1234 h	Operating time
Pcd 1234 h	Operating time with flow rate
Fcd 123 h	Missing time
K 12345678	Property number, 8 digits
D 100506	Date
SD 3105--	Yearly set day (DD.MM)
123456.7 kWh	Energy for previous year on set day
1234567 m <sup>3</sup>	Volume for previous year on set day
FW 1 5-00	Firmware version

**Service loop  
LOOP 2**

MP 60 min	Measuring period for maximum calculation
-----------	--

**Service loop  
LOOP 3**

0 07,11 M	Monthly value (set day)
123456,7 kWh	Energy on set day
T 1234567 kWh	Tariff register 1 on set day
1234567 m <sup>3</sup>	Volume on set day
Ma 3899 m/h St 1306,11	Max. flow rate on set day, at 2-second intervals with date stamp
Ma 2889 kW St 1306,11	Max. power on set day, [SEP] at 2-second intervals with date stamp
MV 988 °C St 1306,11 MR 877 °C St 1306,11	Max. temperatures on set day, at 2-second intervals with date stamp, for temperature heat or cold side
Fd 123 h	Missing time count on set day

<b>!</b>	<b>NOTICE</b>
	Changing the number of months to be read via the service software impacts the number of months that can be called up via the LCD.

**Service loop  
LOOP 4**

T2 0000 m/h ' 0000 m/h	Current tariff, at 2-second intervals with threshold value 1
FP 200 SEC	Measuring interval for flow rate
TP 30 SEC	Measuring interval for temperature
Modul 1 MB	Module 1: M-bus module
API 127	M-bus primary address 1
A 12345678	M-bus secondary address 8-digit
Modul 2-1 CE Modul 2-2 CV	Module 2: Pulse module; channel 1 = Energy, Channel 2 = Volume; at 2-second intervals
PO1 12500 Wh/l	Valency for energy pulses *)
PO2 00250 L/l	Valency for volume pulses *)
PO3 2ms	Pulse duration in ms *)

\*) For "fast pulses"

### Previous year's values

The electronics unit stores the meter readings for energy, volume, tariff register, missing time, and flow measuring time as well as the current maximum values of flow rate, power, temperature differential, temperature heat and cold side with their date stamps on a yearly set day.

### Monthly values

The processor unit stores the meter readings for energy, volume, the tariff register, missing time, and flow rate measuring time as well as the monthly maxima for flow rate, power, temperature differential, temperature heat and cold side with their date stamp for up to **60 months** on the set day of each month.

<b>!</b>	<b>NOTICE</b>
	Central European Time (CET) is the default time. Storage is performed at the appropriate times if daylight saving time is activated. Previous year's values and monthly values can also be read out via the optical interface.

### Error messages

The meter continuously performs self-diagnostics, allowing it to detect a number of mounting or device errors and to display them.

Error code	Error	Notes on service
FL nEG	Wrong direction of flow	Check flow or installation direction; correct if necessary
<b>If necessary, alternating with:</b>		
DIFF nEG	Negative temperature differential	Check place of installation of sensors; replace as required
<b>If necessary, alternating with:</b>		
F0	Flow cannot be measured	Air in the measuring section/pipe; vent the pipe (as supplied)
F1	Interruption in temperature sensor heat side	Check sensor; replace as required
F2	Interruption in temperature sensor cold side	Check sensor; replace as required
F3	Electronics for temperature assessment defective	Replace meter
F4	Battery exhausted; problem in connection with power supply	Replace battery; check connection
F5	Short circuit in temperature sensor heat side	Check sensor; replace as required
F6	Short circuit in temperature sensor cold side	Check sensor; replace as required



Error code	Error	Notes on service
F7	Fault in the internal memory	Replace meter
F8	Errors F1, F2, F3, F5, or F6 pending for more than 8 hours, detection of tampering attempts. No further measurements are made	Action is based on the error code. Service must reset error message F8
F9	Error in the electronics	Replace meter

### Standard parameters

The UH50.. comes programmed as follows:

- Set day [TT.MM]: 01.01



### Power supply

The UH50.. can be powered by a power supply or battery.

### Automatic mains detection

The power supply detects whether line voltage is present. The signal is provided to the UH50... The device automatically detects whether it is powered by a battery or a power supply.

### Power packs

	
Power pack AC/DC 24 V WZU-ACDC24-50	Power pack AC 110/230 V WZU-AC110/230-15 WZU-AC110/230-50

### Batteries

	
Standard battery (2 AA) WZU-BA+GUM	Universal battery (D-cell) WZU-BDS

### Battery life

Battery life depends on the type of battery and requirements (e.g. short timebase, analog module, etc.).

<b>!</b>	<b>NOTICE</b>
	Install only batteries approved by the manufacturer.

Requirements (with timebase Q = 4 s and T = 30 s)	6 years	11 years	16 years	Power pack AC 110/230 V; AC / DC 24 V
<b>Pulse module</b> (Standard pulses) <b>M-bus module G4</b> (Normal read mode 15 min.) <b>BACnet/Modbus module</b> (Read > 10 min.)	2x AA cell	C	D	Yes
<b>RF module 868 MHz</b> (stationary, 15 sec. transmission interval) <b>LoRaWAN module</b> (Transmission interval 160 min.)	D	D	D	Yes
<b>RF module 868 MHz</b> (mobile, 16 sec. transmission interval) <b>LoRaWAN module</b> (Transmission interval 60 min.)	D	D	-	Yes
<b>M-bus module G4</b> (Fast read mode 4 sec.) <b>Pulse module</b> (Fast pulses) <b>Analog module</b> <b>BACnet/Modbus module</b> (Read < 10 min.)	D	-	-	Yes
<b>Fast timebase</b> (for timebase Q = 4 s and timebase T = 4 s)	D	-	-	Yes
<b>GPRS module</b>	-	-	-	Yes

## Communication

### Communication module

The communication modules are connected via a 6-pole reaction-free plug, enabling them to be installed or replaced at any time.

**Compliance with ESD regulations must be ensured.**

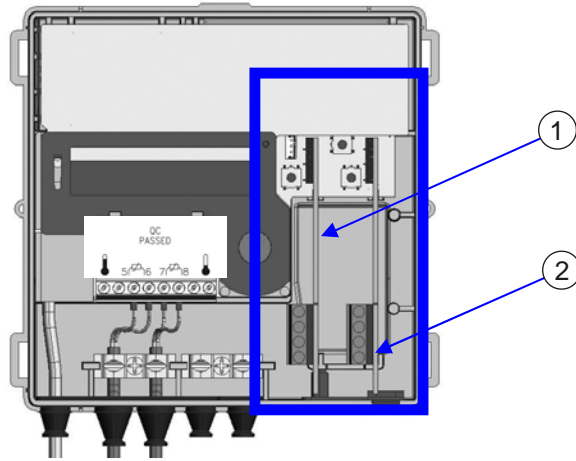

1 Module 1 2 Module 2

The UH50.. meters are equipped with an optical interface as standard. Also, up to 2 of the following communication modules can be used for remote readout:

Pulse module	WZU-P2
M-bus module	WZU-MB G4
M-bus module with 2 pulse inputs	WZU-MI
Analog module	WZU-AM
BACnet/Modbus module	WZU-485E-BAC, WZU-485E-MOD
RF module, 868 MHz	WZU-RF, WZU-RF-EXT
GPRS module	WZU-GPRS, WZU-GPRS-ANT
LoRaWAN module	WZU-LoRa, WZU-LoRa-EXT

These modules have no impact on consumption metering and can therefore be replaced at any time **without having to destroy the security seal**.

Within 30 seconds after mounting (in case of the analog module up to 2 minutes), the meter automatically detects the module used and is then ready for  communication or for delivering pulses.

The type of module used can be displayed within the service loop (loop 4) based on the display parameters.

## Permissible module combinations

AM	Analog module	Step 1: Slot for module 2 is equipped with...						
MB G4	M-bus module							
MB MI	M-bus module							
RF	RF module							
GPRS	GPRS module							
BACnet	BACnet module							
Modbus	Modbus module							
		AM (3)	Pulse module		MB G4	GPRS	RF	LoRa
			"Standard"	"Fast" (1)				
Step 2: Slot for module #1 can be equipped with...	AM	Yes	Yes	Yes	Yes	No	Yes	Yes
	Pulse module (2) "Standard"	Yes	Yes	Yes	Yes	Yes	Yes	Yes
	MB G4	Yes	Yes	Yes	Yes	Yes	Yes	Yes
	MB MI	Yes	Yes	Yes	Yes	No	Yes	Yes
	BACnet	No	No	No	Yes (4)	No	No	No
	Modbus	No	No	No	Yes (4)	No	No	No

### Restrictions:

(1) Only 1 module with fast pulses is possible; and only permissible in slot 2;

min. pulse duration:

- 2 ms, if pulse module 1 is not fitted
- 5 ms, if pulse module 1 is fitted

(2) Subsequent mounting of a further pulse module in module slot 1 can result in changed output values for module 2!

(3) Do not insert the analog module in slot 2 on meters powered by AC 110/230 V

(4) Only one of the two modules may be operated in fast readout mode at an update interval of less than 15 minutes.

### Connection terminals

Multipolar connection terminals are used to connect external cables to the modules.

Choice of connections:

- Solid or stranded wire 0.2...2.5 mm<sup>2</sup>
- Stranded wire with ferrule 0.25...1.5 mm<sup>2</sup>
- Cable sizes 26 – 14 AWG

Multiline connection (2 lines of same cross-sectional area)

- Solid or stranded wire 0.2...0.75 mm<sup>2</sup>
- Stranded wire with ferrule without plastic sleeve 0.25...0.34 mm<sup>2</sup>
- Stranded wire with TWIN ferrule and plastic sleeve 0.5...0.75 mm<sup>2</sup>

Recommended screwdriver 0.6x3.5 mm

Tightening torque 0.4 Nm

The exterior diameter must be between 4 and 6 mm. All wiring must be able to be guided to the meter through the existing bushings. It may be convenient to connect the cables before the meter in a single multi-conductor cable on a split box.

Do not connect shielded cables to the side of the meter (connect to one end only).

**Pulse module  
WZU-P2**

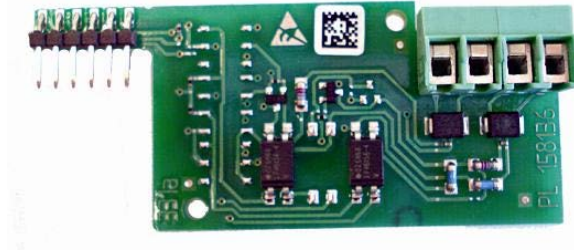

**Function description**

The pulse module WZU-P2 enables the meter to communicate with a pulse collector to transmit measured values. It outputs pulses that can be derived from the energy, volume, tariff register 1 or tariff register 2. Two channels are available; their function can be adapted using the service software.

The outputs are in the form of standard pulses or "fast pulses". The pulse duration is identical for channel 1 and channel 2.

<b>!</b>	<b>NOTICE</b>
	The module can be plugged into both slots, but fast pulses can only be output via slot 2.

**Standard pulses**

Standard pulse valences

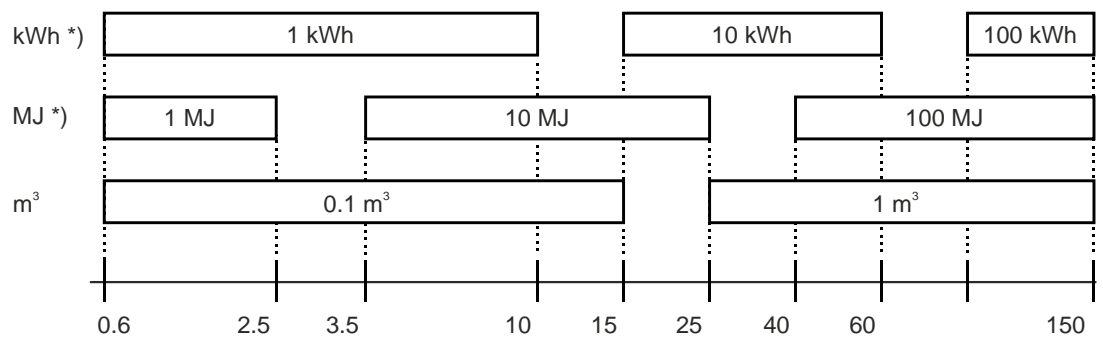

Nominal flow in m³/h

\*) depending on the unit for heat energy display

**Pulses for energy, volume, and tariff register**

Period duration >200 ms

Pulse duration: 100 ms conducting

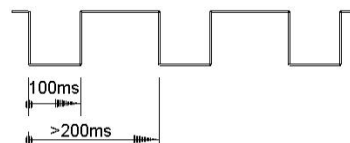

**Pulse for operating states**

"Ready" Pulsed "conducting", i.e. 0.1...0.25 ms pulse duration, 500 ms period

"Fault" Constant "non-conducting"



**Fast pulses**

Applications, such as controllers or flow measuring sections, require higher pulse rates. The service software configures the parameters required for this purpose (pulse valency, pulse duration).

The maximum pulse frequency is 33 Hz.

<b>!</b>	<b>NOTICE</b>
	When battery-powered, a D-cell is required!

The following can be set:

- Pulse type: "linear" or "scaled" pulses
- Pulse output: Energy or volume
- Pulse duration, if only 1 pulse module is fitted:
  - From 2 ms to 100 ms in increments of 1 ms
- Pulse duration, if 2 pulse modules are fitted:
  - From 5 ms to 100 ms in increments of 5 ms

A suitable device can be used to receive and evaluate the pulses. Enter the settings in accordance with the controller's data sheet.

Linear pulses are outputted proportionally to the measured value. In the case of scaled pulses, the number of pulses at the upper and lower end of the range can be defined. In this case, the pulse receiving device can detect a wiring error, for example.

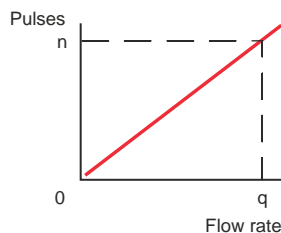

Linear pulses

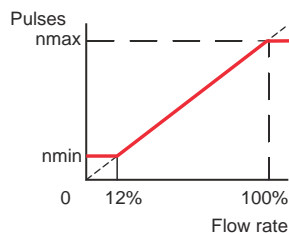

Scaled pulses

**Display on LCD**

Connection of outputs (standard version):

**CE, C2, CV, CT or RI**

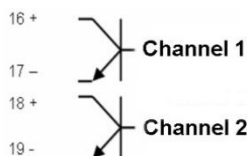

## M-Bus modules

WZU-MB G4

WZU-MI



### Function description

The M-bus modules (WZU-MB G4 and WZU-MI) are used by the meter to communicate with an M-bus central unit to transmit measured values.

With the 2 M-bus modules, the secondary address is identical for both modules. It can be adjusted on the device using the module on slot 1 or via M-bus.

The data on the M-bus module is refreshed every 15 minutes.

A shorter sampling cycle can be set using the UltraAssist software.

The modules are available in 2 different versions:

WZU-MB G4	<b>M-bus module</b> for heat and heat/cooling energy meters, generation 4, recommended as of firmware 5.15 per EN 1434-3
WZU-MI	<b>M-bus module with 2 pulse inputs</b> for heat and heat/cooling energy meters, generation 4, recommended as of firmware 5.15 per EN 13757 and EN 1434-3



### NOTICE

Module WZU-MB G4 can be used in both slots. Always plug module WZU-MI into slot 1.

## M-bus module with 2 pulse inputs

WZU-MI

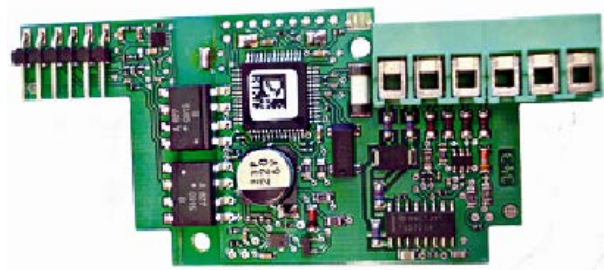

In addition to the M-bus connection facility, the WZU-MI module has 2 pulse inputs to connect metering pulses from hot and cold water meters with Reed contact, relay or open collector. The cumulated volume is calculated based on the pulses and the set pulse valency, stored in the processor unit at 5-minute intervals and passed on via M-bus.

<b>!</b>	<b>NOTICE</b>
	<b>The volume values calculated by the meter from the pulse inputs cannot be officially calibrated.</b>

In addition to possible power supply from the M-bus connection, the WZU-MI module is equipped with a battery. It powers the module processor and the pulse input, if no M-bus voltage is applied. Either isolated contacts (e.g. relay or Reed contacts) or electronic transmitters (open collectors) can be used as pulse transmitters for the pulse inputs. If an open collector circuit is used as the transmitter of the pulse inputs, the cable must always be electrically isolated from the M-bus inputs of the WZU-MI module.

**BACnet/Modbus module  
WZU-485E-BAC  
WZU-485E-MOD**



The processor unit uses both modules to communicate over ModBus® or BACnet™. The ModBus® module is suitable (and preconfigured) for data transmission per the ModBus®-RTU protocol over RS485. The BACnet™ module is suitable (and preconfigured) for data transmission per the BACnet™ protocol over RS485 and BACnet™ MS/TP.

**Technical design**

WZU-485E-MOD	RTU communication over RS485, transmission rate up to 19200 baud, setting the transmission rate and parity of the software (USB, cable connection), refresh rate up to 10 sec. For UC50.. and for UH50.. as of firmware 5.15 and higher
WZU-485E-BAC	MS/TP communication over RS485, transmission rate up to 76800 baud, setting the transmission rate and parity of the software (USB, cable connection), refresh rate up to 10 sec. For UC50.. and for UH50.. as of firmware 5.15 and higher

Both modules are externally powered with AC/DC 24 V and galvanically isolated from the processor unit.

Switch off the module power supply before connecting it to the PC using the USB cable.

The micro USB interface is used exclusively to configure the communication protocol and speed.



## Analog module WZU-AM



### Function description

The analog module (WZU-AM) converts the measured value from the meter to an analog signal. Each module has 2 channels with functions that can be configured independently. The service software configures the unit (selection of measured value and output range). The output signal is refreshed at 4-second intervals.



### NOTICE

The analog module can be plugged into either of the 2 slots and 2 modules can be used concurrently.

### Power supply

The module must be powered via an external power pack (e.g. WZU-NE24). The 2 cables of the power pack are interchangeable. The 2 analog modules can be powered by the same power pack.

The module(s) and the meter can be connected to the same power outlet if the meter is mains-powered (AC/DC 24 V). In this case, the wires must be bridged on module WZU-AM; the plug-in terminals on the meter's power pack are not suited for that purpose.

If a meter is used with an analog module, a D-cell is required – if battery-powered.

### External fuse

Each analog module **requires** its own external fuse.

## RF modules, 868 MHz WZU-RF/WZU-RF-EXT

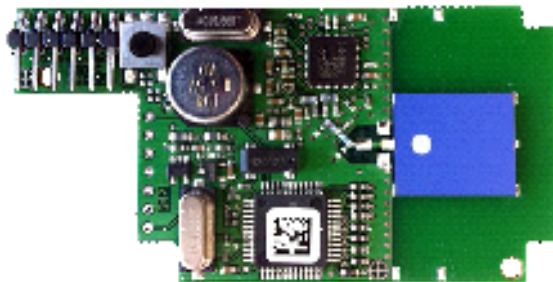

### Function description

The RF modules (WZU-RF and WZU-RF-EXT) enable the meter to communicate wirelessly with a control unit at 868 MHz. They support data transmission conforming to OMS and DSMR. The meter time can be set when operating in conformance with DSMR. The maximum range is 400 meters.



## NOTICE

The module must be plugged into slot 2.

The module is available in 2 different versions:

- WZU-RF           Module with internal antenna
- WZU-RF-EXT   Module with external antenna

### Data output conforming to OMS

The following data is available:

- Current energy
- Current volume
- Current power
- Current flow rate
- Current temperatures heat and cold side
- Error (manufacturer-specific)
- Current time stamp (type I)

Other data telegrams are available on request (e.g. special telegrams for mobile data acquisition).

### Power supply

The RF module is powered via the meter. A D-cell is required if the meter is battery powered.

### LoRa module

#### WZU-LoRa/WZU-LoRa-EXT



The Long Range Wide Area Network (LoRaWAN) is a low-power network protocol. The LoRa alliance establishes the LoRaWAN specification; it is freely available and uses a special modulation technology.

The LoRaWAN module sends the meter data over a LoRaWAN wireless network to an application server (control unit) that the end customer can access. The meter data is transmitted immediately after start. The module can be configured using the mobile APP 'LoRaWAN MCM'.

The transmission type 'Standard' for the LoRa telegram includes the following data points:

- Energy
- Volume
- Power
- Flow rate
- Flow temperature
- Return temperature
- Serial number
- Error flag

At a transmission interval of 60 minutes, a battery life of 11 years can be achieved; at a transmission interval of 160 minutes, up to 16 years at good transmission quality.

<b>!</b>	<b>NOTICE</b>
	The module must be plugged into slot 2.

### GPRS module WZU-GPRS

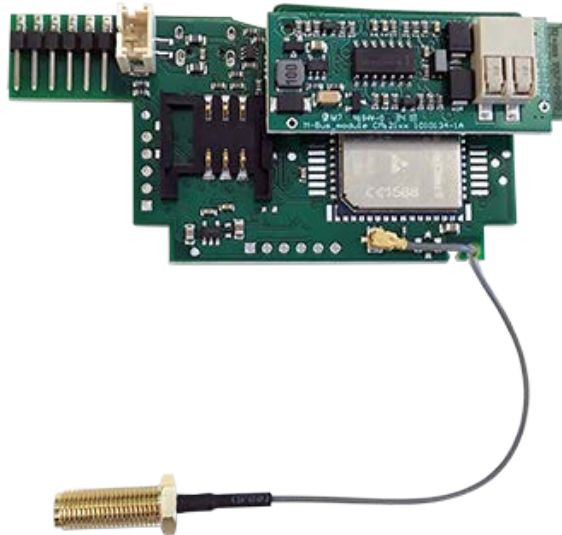

#### Function description

The module (WZU-GPRS) is a GSM/GPRS module with M-bus master. The module reads the values of the meter that support the M-bus protocol and stores the data. It is supplied complete with an external antenna.

#### Properties

- Reading and storing measured values of the heat/cooling energy meter
- Reading and storing measured values of any metering device conforming to the M-bus standard protocol
- Collection of measured values per e-mail, FTP, http, SMS transparent GSM or TCP
- Configurable report templates for manufacturer-specific reports on values, about the system, etc.
- Configurable per SMS, http, or Telenet
- Updating applications, firmware and resources via GPRS remote control

<b>!</b>	<b>NOTICE</b>
	The module must be plugged into slot 2.

#### M-bus

The module has a built-in M-bus master, capable of reading up to another 8 M-bus meters. If the bus is overloaded, communication problems with the connected slaves occur.

All connected M-bus devices (slaves) must have a unique M-bus secondary address.

### Power supply

The module (WZU-GPRS) is supplied complete with the required power supply module (rated voltage AC 100...240 V or AC/DC 24 V).

### Communication protocols

- E-mail via SMTP with authentication mode HELO, EHLO
- Passive FTP mode with authentication and change of remote directory
- HTTP POST and GET
- GSM data transparent M-bus @ 300 and 2400 baud and GSM data console TCP  
Transparent M-bus @300 and 2400 baud and TCP console
- SMS for configuration
- Internet time synchronization with NTP or daytime protocol

### Tariff control

The following options are available for tariff control.

<b>!</b>	<b>NOTICE</b>
	The summation of energy and volume in the standard registers is performed independently of the tariff situation!

### Threshold value tariff (tariffs T2, 3, 4, 5, 6)

Tariff registers 1, 2 and 3 can be controlled via up to 3 threshold values.

Either energy or volume can be added up in the tariff registers. The threshold values can be derived from the flow rate (tariff T2), power (tariff T3), temperature cold side (tariff T4), the flow temperature heat side (tariff T5), or the temperature differential (tariff T6).

### Supplied energy / adjusted energy (tariff T7)

In tariff register 1, the energy calculated from the temperature heat side is totaled (and not from the temperature differential).

The Adjusted Energy function (as of FW 5.24) adds the energy in tariff register 1 that is calculated from the reference temperature and the temperature on the warm side.

### Returned energy (tariff T8)

In tariff register 1, the energy calculated from the temperature cold side is totaled (and not from the temperature differential).

### Heating/cooling energy meter (tariff T9)

In tariff register 1, the measured cooling energy is totaled; in tariff register 2, the measured heat energy. In both cases, a threshold can be defined via the temperature heat side (cold threshold, heat threshold).

Heat threshold exceeded and temperature difference  $> +0.2$  K

=> The heat quantity is acquired

Cold threshold is breached and temperature differential  $< -0.2$  K

=> Cooling quantity is acquired

<b>!</b>	<b>NOTICE</b>
	It is also measured in the event of negative temperature differentials.

### Tariff control via time switch (tariff T10)

For tariff control, one switch-off time and one switch-on time per day can be defined. At the switch-on time, the energy or volume is totaled in tariff register 1 and ended at the switch-off time accordingly.

### Tariff control via M-bus (tariff T11)

In tariff registers 1, 2 and 3, either energy or volume can be totaled. With the relevant M-bus command, one of the 3 tariffs can be activated or all tariffs can be deactivated.

### Surcharge quantity tariff by means of return temperature (tariff T12)

The energy is totaled based on the temperature cold side in tariff registers 1 or 2.

The totaled energy is calculated from the temperature differential cold side and a defined return threshold (and not from the temperature differential).

Return threshold exceeded: T1 is totaled.

Return threshold breached: T2 is totaled.

### Display of tariff situation on the LCD

The current tariff state is displayed in the user loop together with the energy or the volume.

No tariff state is displayed for tariffs T7 and T8.







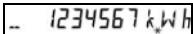



For tariffs T2, T3, T4, T5, T6, T10, T11, and T12

	No tariff register active
	Tariff register 1 active
	Tariff register 2 active
	Tariff register 3 active

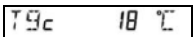
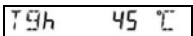
For tariff T9 (cooling energy/heat meter)

	No tariff register active
	Tariff register 1 active
	Tariff register 2 active

The type of tariff and the associated parameters are displayed in service loop 4.

	For T2, T3, T4, T5, and T6
	At 2-second intervals with threshold value 1/2/3
	For T7
	For T8
	For T9
	At 2-second intervals
	
	For T10
	Switching times at 2-second intervals
	For T11
	For T12

The contents of the tariff registers is displayed in the user loop after the energy.

For tariffs T2, T3, T4, T5, T6, T10, T11, and T12

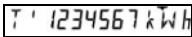
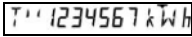
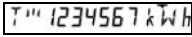
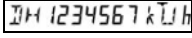
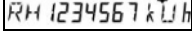
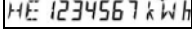
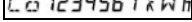
	Tariff register 1
	Tariff register 2
	Tariff register 3 (not for T12)
	For tariff T7
	For tariff T8
	For tariff T9
	

### Log functions

In the internal logbook, meteorologically relevant events (errors, states, actions) are stored in chronological order with the time of occurrence. The acquired events are predefined. Logbook data cannot be deleted.

Each event is stored in a separate 4-level shift register; the overflows are transferred to a 25-level circulating buffer. So that at least the last 4 times can be traced for each event.

In a monthly register, the error states are stored for the current month and the past 18 months (without time stamp).

Serial no.	Description
1	F0 = Air in measuring tube
2	F1 = Interruption in temperature sensor heat side
3	F2 = Interruption in temperature sensor cold side
4	F3 = Error temperature electronics
5	F5 = Short circuit in temperature sensor heat side
6	F6 = Short circuit in temperature sensor cold side
7	F8 = Sensor error >8 hours
8	F9 = ASIC error
9	Above max. temperature in the flow measuring section
10	Below min. temperature in the flow measuring section
11	Max. flow rate qs exceeded
12	Soiling prewarning
13	Mains voltage off
14	CRC error occurred
15	Adjustment values parameterized
16	F7 (EEPROM) prewarning
17	Reset made
18	Date/time of day parameterized
19	Yearly set day parameterized
20	Monthly set day parameterized
21	Master reset made
22	All times deleted
23	Error time was deleted
24	Maximum was deleted

The service software configures and reads out the data via the optical interface.

### Data logger

The data logger (optional) permits archiving of data that the user can select from a predefined set of values. The data logger contains 4 archives to which 8 channels can be assigned. The data can be assigned to any of the channels. The service software is used for the configuration.

Archive	Time base	Storage depth	Averaging time for maximum
Hourly archive	1 hour	45 days	1 hour
Daily archive	1 day	65 days	1 hour
Monthly archive	1 month	15 months	1 hour
Yearly archive	1 year	15 years	1 hour/24 hours

\*) For measuring periods of less than 1 hour, the highest value from the maximum values as calculated within 1 hour applies

The data is recorded with their values and time stamps. The service software configures and reads out the data via the optical interface.

<b>!</b>	<b>NOTICE</b>
	Data transmission is in a manufacturer-specific format.

	Value set for data to be recorded
<b>Meter readings at the end of the period for...</b>	Energy Tariff register 1, 2, 3 Volume Operating time *) Fault duration *) Pulse input 1 Pulse input 2 *) Depending on configuration: Hours or days
<b>Instantaneous values at the end of the period for...</b>	Power Flow rate Temperature heat side Temperature cold side Temperature difference Indication of errors
<b>Maximum for...</b>	Power Flow rate Temperature heat side Temperature cold side Temperature difference

## Type summary

The **Ultrasonic heating and cooling energy meters UH50..** listed below are equipped as follows:

Mounting location	In return
Rated pressure	PN 16 (PS16) /PN 25 (PS25)
Length of control cable	1.5 m/3 m
Sensor mounting	Return sensor integrated in the flow measuring section Return sensor integrated in the flow measuring section Installing the return sensor in the measuring tube as an option
Sensor type	Pt500, DS M10x1, length 27.5 mm Pt500, DS M10x1 mm, length 38 mm Pt500, Ø 5.2 mm, length 45 mm Pt500, Ø 6 mm, length 100 mm Pt500, Ø 6 mm, length 150 mm
Temperature sensor cable length	1.5 m/5 m
Power supply	Without power supply; different types of power supply available
Communication	Without communication; different types of modules available
Display	kWh/MWh

### Heat meter

Options	Order number	Type
<b>0.6 m<sup>3</sup>/h</b> nominal flow rate, mounting length 110 mm, connecting thread G ¾", PN 16, control cable length 1.5 m, Pt500, DS M10x1 mm, sensor length 27.5 mm, cable length 1.5 m, return sensor integrated in the flow measuring section, energy unit display kWh	S55561-F112	UH50-A05-00
<b>1.5 m<sup>3</sup>/h</b> nominal flow rate, mounting length 110 mm, connecting thread G ¾", PN 16, control cable length 1.5 m, Pt500, DS M10x1 mm, sensor length 27.5 mm, cable length 1.5 m, return sensor integrated in the flow measuring section, energy unit display kWh	S55561-F113	UH50-A21-00
<b>1.5 m<sup>3</sup>/h</b> rated flow, mounting length 190 mm, connecting thread G 1", PN 16, control cable length 1.5 m, Pt500, DS M10x1 mm, sensor length 27.5 mm, cable length 1.5 m, return sensor integrated in the flow measuring section, energy unit display kWh	S55561-F180	UH50-A23-00



<b>2.5 m<sup>3</sup>/h</b> nominal flow rate, mounting length 130 mm, connecting thread G 1", PN 16, control cable length 1.5 m, Pt500, DS M10x1 mm, sensor length 27.5 mm, cable length 1.5 m, return sensor integrated in the flow measuring section, energy unit display in kWh	S55561-F114	UH50-A36-00
<b>2.5 m<sup>3</sup>/h</b> rated flow, mounting length 190 mm, connecting thread G 1", PN 16, control cable length 1.5 m, Pt500, DS M10x1 mm, sensor length 27.5 mm, cable length 1.5 m, return sensor integrated in the flow measuring section, energy unit display in kWh	S55561-F181	UH50-A38-00
<b>3.5 m<sup>3</sup>/h</b> nominal flow rate, mounting length 260 mm, connecting thread G 1¼", PN 16, control cable length 1.5 m, Pt500, DS M10x1 mm, sensor length 38 mm, cable length 1.5 m, return sensor integrated in the flow measuring section, energy unit display in kWh	S55561-F115	UH50-A45-00
<b>6 m<sup>3</sup>/h</b> nominal flow rate, mounting length 260 mm, connecting thread G 1¼", PN 16, control cable length 1.5 m, Pt500, DS M10x1 mm, sensor length 38 mm, cable length 1.5 m, return sensor integrated in the flow measuring section, energy unit display in kWh	S55561-F116	UH50-A50-00
<b>10 m<sup>3</sup>/h</b> nominal flow rate, mounting length 300 mm, flanged DN 40, PN 25, control cable length 1.5 m, Pt500, Ø 6 mm, sensor length 100 mm, cable length 5 m, return sensor not integrated in the flow measuring section, energy unit display in kWh	S55561-F117	UH50-A61-00
<b>15 m<sup>3</sup>/h</b> nominal flow rate, mounting length 270 mm, flanged DN 50, PN 25, control cable length 3 m, Pt500, Ø 6 mm, sensor length 100 mm, cable length 5 m, return sensor not integrated in the flow measuring section, energy unit display in MWh	S55561-F118	UH50-A65-00
<b>25 m<sup>3</sup>/h</b> nominal flow rate, mounting length 300 mm, flanged DN 65, PN 25, control cable length 3 m, Pt500, Ø 6 mm, sensor length 100 mm, cable length 5 m, return sensor not integrated in the flow measuring section, energy unit display in MWh	S55561-F119	UH50-A70-00
<b>40 m<sup>3</sup>/h</b> nominal flow rate, mounting length 300 mm, flanged DN 80, PN 25, control cable length 3 m, Pt500, Ø 6 mm, sensor length 150 mm, cable length 5 m, return sensor not integrated in the flow measuring section, energy unit display in MWh	S55561-F120	UH50-A74-00

<b>60 m<sup>3</sup>/h</b> nominal flow rate, mounting length 300 mm, flanged DN 100, PN 25, control cable length 3 m, Pt500, Ø 6 mm, sensor length 150 mm, cable length 5 m, return sensor not integrated in the flow measuring section, energy unit display in MWh	S55561-F121	UH50-A83-00
---	-------------	-------------

#### Heat/cooling energy meter

Options	Order number	Type
<b>0.6 m<sup>3</sup>/h</b> nominal flow rate, mounting length 110 mm, connecting thread G ¾", PN 16, control cable length 1.5 m, Pt500, DS M10x1 mm, sensor length 27.5 mm, cable length 1.5 m, return sensor integrated in the flow measuring section, energy unit display kWh	S55561-F122	UH50-C05-00
<b>0.6 m<sup>3</sup>/h</b> nominal flow rate, mounting length 110 mm, connecting thread G ¾", PN 25, control cable length 1.5 m, Pt500, DS M10x1 mm, sensor length 27.5 mm, cable length 1.5 m, return sensor installation in the measuring tube, energy unit display in kWh	S55561-F252	UH50-C06-00
<b>1.5 m<sup>3</sup>/h</b> nominal flow rate, mounting length 110 mm, connecting thread G ¾", PN 16, control cable length 1.5 m, Pt500, DS M10x1 mm, sensor length 27.5 mm, cable length 1.5 m, return sensor integrated in the flow measuring section, energy unit display kWh	S55561-F123	UH50-C21-00
<b>1.5 m<sup>3</sup>/h</b> nominal flow rate, mounting length 110 mm, connecting thread G ¾", PN 25, control cable length 1.5 m, Pt500, DS M10x1 mm, sensor length 27.5 mm, cable length 1.5 m, return sensor installation in measuring tube optional, energy unit display kWh	S55561-F253	UH50-C22-00
<b>1.5 m<sup>3</sup>/h</b> nominal flow rate, mounting length 110 mm, connecting thread G 1", PN 25, control cable length 1.5 m, Pt500, DS M10x1 mm, sensor length 27.5 mm, cable length 1.5 m, return sensor installation in the measuring tube optional, energy unit display kWh	S55561-F254	UH50-C25-00
<b>2.5 m<sup>3</sup>/h</b> nominal flow rate, mounting length 130 mm, connecting thread G 1", PN 16, control cable length 1.5 m, Pt500, DS M10x1 mm, sensor length 27.5 mm, cable length 1.5 m, return sensor integrated in the flow measuring section, energy unit display in kWh	S55561-F124	UH50-C36-00

<b>2.5 m<sup>3</sup>/h</b> nominal flow rate, mounting length 130 mm, connecting thread G 1", PN 25, control cable length 1.5 m, Pt500, DS M10x1 mm, sensor length 27.5 mm, cable length 1.5 m, return sensor installation in the measuring tube optional, energy unit display kWh	S55561-F255	UH50-C37-00
<b>2.5 m<sup>3</sup>/h</b> nominal flow rate, mounting length 190 mm, connecting thread G 1", PN 25, control cable length 1.5 m, Pt500, DS M10x1 mm, sensor length 27.5 mm, cable length 1.5 m, return sensor installation in the measuring tube optional, energy unit display kWh	S55561-F256	UH50-C40-00
<b>3.5 m<sup>3</sup>/h</b> nominal flow rate, mounting length 260 mm, connecting thread G 1¼", PN 16, control cable length 1.5 m, Pt500, DS M10x1 mm, sensor length 38 mm, cable length 1.5 m, return sensor integrated in the flow measuring section, energy unit display in kWh	S55561-F125	UH50-C45-00
<b>3.5 m<sup>3</sup>/h</b> nominal flow rate, mounting length 260 mm, connecting thread G 1¼", PN 25, control cable length 1.5 m, Pt500, DS M10x1 mm, sensor length 38 mm, cable length 2.5 m, return sensor installation in the measuring tube optional, energy unit display kWh	S55561-F257	UH50-C47-00
<b>6 m<sup>3</sup>/h</b> nominal flow rate, mounting length 260 mm, connecting thread G 1¼", PN 16, control cable length 1.5 m, Pt500, DS M10x1 mm, sensor length 38 mm, cable length 1.5 m, return sensor integrated in the flow measuring section, energy unit display in kWh	S55561-F126	UH50-C50-00
<b>6 m<sup>3</sup>/h</b> nominal flow rate, mounting length 260 mm, flanged DN 25, PN 25, control cable length 1.5 m, Pt500, Ø 5.2 mm, sensor length 45 mm, cable length 1.5 m, return sensor not integrated in the flow measuring section, energy unit display in kWh	S55561-F258	UH50-C52-00
<b>10 m<sup>3</sup>/h</b> nominal flow rate, mounting length 300 mm, connecting thread G 2", PN 16, control cable length 1.5 m, Pt500, Ø 6 mm, sensor length 100 mm, cable length 2 m, return sensor not integrated in the flow measuring section, energy unit display in kWh	S55561-F259	UH50-C60-00
<b>10 m<sup>3</sup>/h</b> nominal flow rate, mounting length 300 mm, flanged DN 40, PN 25, control cable length 1.5 m, Pt500, Ø 6 mm, sensor length 100 mm, cable length 5 m, return sensor not integrated in the flow measuring section, energy unit display in kWh	S55561-F127	UH50-C61-00

<b>15 m<sup>3</sup>/h</b> nominal flow rate, mounting length 270 mm, flanged DN 50, PN 25, control cable length 3 m, Pt500, Ø 6 mm, sensor length 100 mm, cable length 5 m, return sensor not integrated in the flow measuring section, energy unit display in MWh	S55561-F128	UH50-C65-00
<b>25 m<sup>3</sup>/h</b> nominal flow rate, mounting length 300 mm, flanged DN 65, PN 25, control cable length 3 m, Pt500, Ø 6 mm, sensor length 100 mm, cable length 5 m, return sensor not integrated in the flow measuring section, energy unit display in MWh	S55561-F129	UH50-C70-00
<b>40 m<sup>3</sup>/h</b> nominal flow rate, mounting length 300 mm, flanged DN 80, PN 25, control cable length 3 m, Pt500, Ø 6 mm, sensor length 150 mm, cable length 5 m, return sensor not integrated in the flow measuring section, energy unit display in MWh	S55561-F130	UH50-C74-00
<b>60 m<sup>3</sup>/h</b> nominal flow rate, mounting length 300 mm, flanged DN 100, PN 25, control cable length 3 m, Pt500, Ø 6 mm, sensor length 150 mm, cable length 5 m, return sensor not integrated in the flow measuring section, energy unit display in MWh	S55561-F131	UH50-C83-00



Other types available on request.

#### Power supply modules for UH50..

Component (optional)	Order number	Type
Power pack AC 110/230 V, cable length 1.5 m	S55563-F154	WZU-AC110/230-15
Power pack AC 110/230 V, cable length 5 m	LYU:WZU-AC110/230-50	WZU-AC110/230-50
Power pack AC/DC 24 V, with terminals	S55563-F156	WZU-ACDC24-50
Standard battery (2 AA), for 6 years with holder, applications: Standard pulses, Standard M-bus readout (every 15 minutes)	S55563-F114	WZU-BA+GUM
Universal battery (D-cell) for 6 or 16 years Applications for 16 years: Standard pulses, standard M-bus readout (15 min.) Application for 6 years: All communication modules	S55563-F113	WZU-BDS



Other types available on request.

Communication modules WZU-GPRS and WZU-GPRS-ANT are supplied complete with power supply. In that case, none of the above mentioned power supply modules need be ordered.

### Communication modules for UH50..

Stock no. (optional)	Order number	Type
Pulse module with 2 channels to output standard or "definable" pulses	S55563-F107	WZU-P2
M-bus module for heat and heat/cooling energy meters, generation 4, recommended as of firmware 5.15 As of heat and heat/cooling energy meters firmware 5.17 and module firmware 4.10	S55563-F110	WZU-MB G4
M-bus module with 2 pulse inputs For Generation 4 heat and heat/cooling energy meters as of firmware 5.15 As of heat and heat/cooling energy meters firmware 5.17 and module firmware 4.10	S55563-F108	WZU-MI
BACnet module RS-485 per ASHRAE 135 and ISO 16484-5 for meters as of firmware 5.15	LYU:WZU-485E-BAC	WZU-485E-BAC
Modbus module RS-485 per Modbus RTU protocol for meters as of firmware 5.15	LYU:WZU-485E-MOD	WZU-485E-MOD
RF module 868 MHz per EN 13737-4 only as of meters firmware 5.17	LYU:WZU-RF	WZU-RF
RF module 868 MHz per EN 13737-4 only as of meters firmware 5.17 with external antenna	LYU:WZU-RF-EXT	WZU-RF-EXT
GPRS module with external antenna (magnetic attachment) and with power pack AC 110...230 V as of meter firmware 5.15	LYU:WZU-GPRS	WZU-GPRS
GPRS module with external antenna (for screw mounting) and with power pack AC 110...230 V as of meter firmware 5.15	LYU:WZU-GPRS-ANT	WZU-GPRS-ANT
LoRa module	LYU: WZU-LoRa	WZU-LoRa
LoRa module with external antenna	LYU:WZU-LoRa-EXT	WZU-LoRa-EXT
Analog module	LYU:WZU-AM	WZU-AM
Power pack for analog module	LYU:WZU-NE24	WZU-NE24



Other types available on request.

### Temperature sensors for UH50..

Component	Order number	Type
Pt500, DS M10x1 mm, sensor length 27.5 mm, cable length 1.5 m	LYU:WZU5-2815	WZU5-2815
Pt500, DS M10x1 mm, sensor length 27.5 mm, cable length 2.5 m	LYU:WZU5-2825	WZU5-2825
Pt500, DS M10x1 mm, sensor length 38 mm, cable length 1.5 m	LYU:WZU5-3815	WZU5-3815
Pt500, DS M10x1 mm, sensor length 38 mm, cable length 2.5 m	LYU:WZU5-3825	WZU5-3825

Pt500, PS Ø 5.2x45 mm, cable length 1.5 m	LYU:WZU5-4515	WZU5-4515
Pt500, PS Ø 5.2x45 mm, cable length 5 m	LYU:WZU5-4550	WZU5-4550
Pt500, PL Ø 6x100 mm, cable length 2 m	LYU:WZU5-1020	WZU5-1020
Pt500, PL Ø 6x100 mm, cable length 5 m	LYU:WZU5-1050	WZU5-1050
Pt500, PL Ø 6x150 mm, cable length 2 m	LYU:WZU5-1520	WZU5-1520
Pt500, PL Ø 6x150 mm, cable length 5 m	LYU:WZU5-1550	WZU5-1550

## Mounting accessories for UH50..

### Fittings

Stock no. (optional)	Order number	Type
Mounting set for L = 110 mm, consisting of: 2x ball valve Rp ¾" with union nut G ¾" (WZT-K34-34) 1x ball valve Rp ¾" with connection for the direct installation of temperature sensors M10 x 1 (WZT-K34) 1x spacer 110 mm (WZM-G110) 2x flat seals	LYU:WZT-MS110	WZT-MS110
Mounting set for L = 130 mm consisting of: 2x ball valve Rp 1" with union nut G 1" (WZT-K1-1) 1x ball valve Rp 1" with connection for the direct installation of temperature sensors M10 x 1 (WZT-K1) 1x spacer 130 mm (WZM-G130) 2x flat seals	LYU:WZT-MS130	WZT-MS130
Mounting kit G ¾", consisting of: 2 x fittings G ¾" x R ½" 2 x union nut G ¾" 2 x gasket G ¾"	S55563-F124	WZM-E34
Mounting kit 1", consisting of: 2 x fittings G 1" x R ¾" 2 x union nut G 1" 2 x gasket G 1	S55563-F123	WZM-E1
Mounting kit 1¼", consisting of: 2 x fittings G 1¼" x R 1" 2x union nut G 1¼" 2x gasket G 1¼"	S55563-F125	WZM-E54
Mounting kit 2", consisting of: 2 x fittings G 2" x R 1½" 2 x union nut G 2" 2 x gasket G 2"	LYU:WZM-E2.1	WZM-E2.1
Adapter piece 110 mm G ¾" to 130 mm G ¾": 1 x extension G ¾ B" to G ¾ B" 1 x gasket G ¾"	LYU:WZM-V130	WZM-V130

Adapter piece 110 mm G ¾" to 130 mm G 1": 2 x extension G ¾ B" to G 1 B" 2 x gasket G ¾" 2 x gasket G 1"	LYU:WZM-V130.G1	WZM-V130.G1
Adapter piece 110 mm G ¾" to 165 mm G ¾": 1 x extension G ¾ B" to G ¾ B" 1 x gasket G ¾"	LYU:WZM-VE165	WZM-VE165

Adapter piece 110 mm G ¾" to 190 mm G 1": 2 x extension G ¾ B" to G 1 B" 2 x gasket G ¾" 2 x gasket G 1"	LYU:WZM-V190	WZM-V190
---	--------------	----------

### Spacers and gaskets

Stock no. (optional)	Order number	Type
Spacer G ¾", length 110 mm, incl. 2 gaskets	LYU:WZM-G110	WZM-G110
Spacer G 1", length 130 mm, incl. 2 gaskets	LYU:WZM-G130	WZM-G130
Spacer G 1", length 190 mm, incl. 2 gaskets	LYU:WZM-G190	WZM-G190
Spacer G 1¼", length 260 mm, incl. 2 gaskets	LYU:WZM-G260	WZM-G260
Spacer DN 20, length 190 mm, PN 16, incl. 2 flat gaskets	LYU:WZM-F190	WZM-F190
Spacer DN 25, length 260 mm, PN 16, incl. 2 flat gaskets	LYU:WZM-F260	WZM-F260
Spacer DN 50, length 270 mm, PN 16, incl. 2 flat gaskets	LYU:WZM-F270	WZM-F270
Spacer DN 40, length 300 mm, PN 16, incl. 2 flat gaskets	LYU:WZM-F300	WZM-F300
Spacer DN 65, length 300 mm, PN 16, incl. 2 flat gaskets	LYU:WZM-F300.65	WZM-F300.65
Spacer DN 80, length 300 mm, PN 16, incl. 2 flat gaskets	LYU:WZM-F300.80	WZM-F300.80
Spacer DN 100, length 360 mm, PN 25, incl. 2 flat gaskets	LYU:WZM-F360.10-25	WZM-F360.100-25
Sealing disk G ¾", for threaded connection R ½"	LYU:9060944002	9060944002
Sealing disk G 1", for threaded connection R ¾"	LYU:9060944003	9060944003
Sealing disk G 1¼", for threaded connection R 1"	LYU:9060944004	9060944004

Sealing disk DN 40, q <sub>p</sub> 10 m <sup>3</sup> /h	LYU:9060944024	9060944024
Sealing disk DN 50, q <sub>p</sub> 15 m <sup>3</sup> /h	LYU:9060944025	9060944025
Sealing disk DN 65, q <sub>p</sub> 25 m <sup>3</sup> /h	LYU:9060944026	9060944026
Sealing disk DN 80, q <sub>p</sub> 40 m <sup>3</sup> /h	LYU:9060944027	9060944027
Sealing disk DN 100, q <sub>p</sub> 60 m <sup>3</sup> /h	LYU:9060944028	9060944028

## Accessories

Accessories	Order number	Type
Welding sleeve with threaded hole for temperature sensor DS M10x1 mm	S55563-F121	WZT-G10
Welding sleeve G ½", 45° to pipe axis, with threaded hole G ½"	S55563-F122	WZT-G12
Welding sleeve G ½", 90° to pipe axis, with threaded hole G ½"	LYU:WZT-GLG	WZT-GLG
Ball valve Rp ½" for mounting the sensor DS M10x1 mm, length 28 mm, max. water temperature 130 °C, PN 25	S55563-F104	WZT-K12
Ball valve Rp ¾" for mounting the sensor DS M10x1 mm, length 28 mm, max. water temperature 130 °C, PN 25	S55563-F120	WZT-K34
Ball valve Rp 1" for mounting the sensor DS M10x1 mm, length 28 mm, max. water temperature 130 °C, PN 25	S55563-F119	WZT-K1
Ball valve Rp 1¼" with connection for the direct installation of temperature sensors DS M10x1 mm, length 38 mm	LYU: WZT-K54	WZT-K54
Ball valve Rp 1½" with connection for the direct installation of temperature sensors DS M10x1 mm, length 38 mm	LYU:WZT-K112	WZT-K112
Ball valve Rp 2" with connection for the direct installation of temperature sensors DS M10x1 mm, length 38 mm	LYU: WZT-K2	WZT-K2
Ball valve Rp ½" with union nut G ¾"	LYU:WZT-K12-34	WZT-K12-34
Ball valve Rp ¾" with union nut G ¾"	LYU:WZT-K34-34	WZT-K34-34
Ball valve Rp ¾" with union nut G 1"	LYU:WZT-K34-1	WZT-K34-1
Ball valve Rp 1" with union nut G 1"	LYU:WZT-K1-1	WZT-K1-1
Ball valve Rp 1¼" with union nut G 1¼"	LYU: WZT-K54-54	WZT-K54-54
Ball valve Rp 2" with union nut G 2"	LYU: WZT-K2-2	WZT-K2-2
Adapter for ball valve to install sensor DS M10x1 mm, length 38 mm	LYU:WZT-KA	WZT-KA
Adapter G ⅜ B" with threaded hole for sensor DS M10x1 mm, incl. gasket G ⅜" made of copper	LYU:WZT-A38	WZT-A38
Adapter G ½ B" with threaded hole for sensor DS M10x1 mm, incl. gasket G ½" made of copper	S55563-F116	WZT-A12
Adapter G ¾ B" with threaded hole for sensor DS M10x1 mm, incl. gasket G ¾" made of copper	LYU:WZT-A34	WZT-A34



Protection pocket G ½ B" made of stainless steel, with threaded hole G ¼", mounting length 100 mm, incl. gasket G ½" made of copper	S55563-F117	WZT-S100
Protection pocket G ½ B" made of stainless steel, with threaded hole G ¼", mounting length 150 mm, incl. gasket G ½" made of copper	S55563-F118	WZT-S150
Protection pocket G ½ B" made of brass, Ø 5.2x35 mm for sensor Ø 5.2x45 mm	S55563-F103	WZT-M35
Protection pocket G ½ B" made of brass, Ø 5.2x50 mm for sensor Ø 5.2x45 mm	LYU:WZT-M50	WZT-M50
Mounting set for sensor Ø 5.2x45 mm, consisting of: - 1 sensor fitting DS M10x1 mm, brass - 2x O-rings - 1x grooved pin - 1 Sensor mounting aid	LYU:WZT-FA	WZT-FA
Mounting set for sensor Ø 5.2x45 mm, consisting of: - 1 sensor fitting M10x1 mm, plastic - 2x O-rings - 1 Sensor mounting aid	LYU:9956230	9956230
Mounting set G ½ B" with threaded hole G ¼" for direct mounting of long sensors	LYU:WZT-A100	WZT-A100
Sealing disk for temperature sensor M10x1 mm, Ø 8.6/5.3, size 1 mm	LYU:9060944001	9060944001
Sealing disc ½" made of copper	LYU:9060948	9060948
Service key to start calibration mode	LYU:9089885	9089885
Mounting plate for top hat rail	LYU:WZU-MH	WZU-MH
Mounting plate for wall mounting	LYU:WZU-WA	WZU-WA
Self-lock seal with sealing wire	LYU:9956186001	9956186001

### Programming accessories

Accessories	Order number	Type
Optical read head with USB interface for PC	LYU:WZR-OP-USB	WZR-OP-USB
Readout and configuration software UltraAssist	Available on request	-

### Readout and parameterization software

For further information about the UltraAssist Light read and parameterization software see chapter "Functions".

### Ordering

When ordering, please provide the quantity, description, product no. and stock no.

Designation	Order number	Type
Ultrasonic heat meter	S55561-F114	UH50-A36-00

### Scope of delivery

Operating and installation instructions in multiple languages are included with the ultrasonic heat and heat/cooling meters.

### Languages

The instructions are supplied in 18 languages:

Bulgarian, Chinese, Croatian, Czech, Dutch, English, French, German, Greek, Hungarian, Italian, Norwegian, Polish, Russian, Slovakian, Slovenian, Spanish, and Turkish.

## Notes

### Mounting

#### Flow measuring section

The mounting position is optional, the mounting location (return) must be in accordance with the type of meter used.

<b>!</b>	<b>NOTICE</b>
	The flow measuring section must be installed in the return on types UH50-A..., UH50-C..., and UH50-G...

Settling paths are not required, neither upstream of nor downstream from the meter. If the meter is installed in the common return of 2 heating circuits (e.g. space heating and DHW), the mounting location must be at an adequate distance from the T-piece (min. 10 x DN) to allow the different water temperatures to properly mix.

Thoroughly flush the plant prior to installing the meter.

Install the flow measuring section between 2 shutoff valves with the arrow pointing in the direction of flow. The sensors must be mounted in the same water circuit as the flow measuring section (observe mixing). Do not separate, shorten, or extend the lines.

Connect the individual wires according to the wiring diagram printed on the meter.

The sensors can be fitted in T-pieces or ball valves, or can be immersed, either directly or in pockets (observe all national regulations).

<b>!</b>	<b>NOTICE</b>
	In Germany, the temperature sensors must be installed submerged for meters to q <sub>p</sub> 6 and to PN16. Immersion sleeves only have to be used in case of higher stress levels.

In any case, the end of the sensors' probe must extend to at least the pipe center.

Temperature sensors and fittings must be sealed to prevent tampering. Overpressure must prevent cavitation across the entire measuring range, that is, at least 1 bar with q<sub>p</sub> and approximately 3 bar with q<sub>s</sub> (at 80 °C).

Only authorized personnel are allowed to remove and replace calibration seals when carrying out service work.

### Ball valve

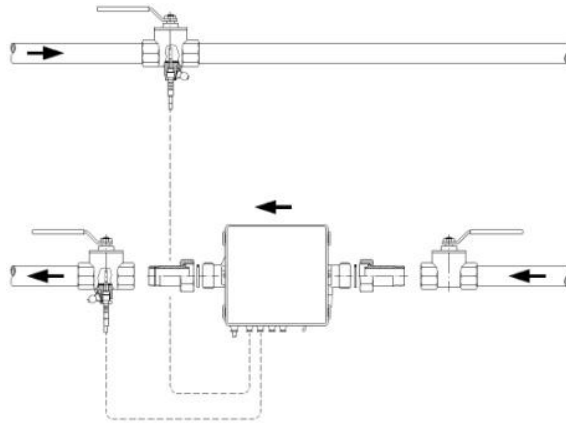

Example of mounting with a ball valve (recommended up to  $q_p$  6)

### Welded sleeve with protection pocket

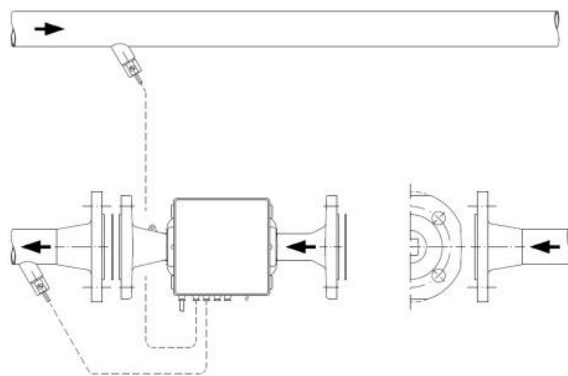

Example of mounting with protection pockets (recommended above  $q_p$  10)

### Required position for the cooling energy meter

To avoid the formation of condensation on cooling energy or combined heat/cooling energy meters, make sure the black cover on the measuring tube points to the side or downward. Install the protection pockets so that the temperature sensor is horizontal or vertical, pointing down. Mount the processor unit away from the flow measuring section (e.g. on the wall). Make sure that condensation cannot run along the connected lines, entering the processor unit (forming a loop downward).

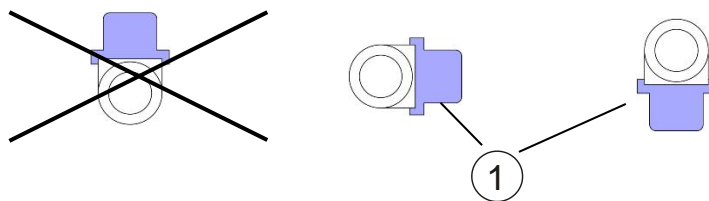

1 Transducer cover

Permissible mounting position when metering cooling energy

### Processor unit

The ambient temperature of the processor unit cannot exceed 55 °C. Avoid direct sunlight. During installation, ensure that no water can penetrate the processor unit during operation.

**For water temperatures between 10 °C and 90 °C**, the processor unit may be left on the flow measuring section or can be fitted to the wall (detached mounting).

For water temperatures above 90 °C and/or below 10 °C, mount the processor unit on the wall (split mounting).

To fit the processor unit to the wall, remove it from the flow measuring section and undo the screws of the adapter plate. The latter must then be secured to the wall so that the processor unit can be replaced on the adapter plate, snapping into place.

<b>!</b>	<b>NOTICE</b>
	<p>On models with removable control wiring, you can disconnect and reconnect the wiring during installation.</p> <ul style="list-style-type: none"><li>• Connect only paired parts (volume measuring section, processor unit) when reconnecting.</li><li>• Note the correct pin assignment.</li><li>• Do not extend nor shorten the control wiring.</li></ul>

## Maintenance

The meters are maintenance-free.  
Observe all national calibration regulations.

## Disposal

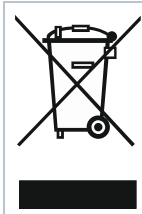

The device is considered an electronic device for disposal in accordance with the European Guidelines and may not be disposed of as domestic garbage.

- Dispose of the device through channels provided for this purpose.
- Comply with all local and currently applicable laws and regulations.
- Dispose of empty batteries in designated collection points.

## Warranty service

The application-related technical data is only guaranteed together with the products mentioned in this data sheet. Siemens rejects any and all warranties in the event that third-party products are used.

**Processor unit**

Function data	
Measuring range (national approvals may differ)	0...180 °C
Range of temperature differential $\Delta\Theta$	3...120 K
Temperature response threshold	0.2 K
Thermal coefficient	Shifting compensated
Temperature-measuring error without sensor	$(0.5 + \Delta\Theta_{\min.}/\Delta\Theta)$ %, max. 1.5% at $\Delta\Theta = 3$ K

Temperature sensor	
Sensing element	Pt500 per EN 60751
Temperature range	0...150 °C (up to 45 mm mounting length) 0...180 °C (from 100 mm mounting length)

Optical interface	
Basic design	Similar to EN 62056-21
Protocol	Per EN 62056-21

Cable length	
Control cable	1.5, 3, and 5 m
Sensor types	DS M10x1 mm, sensor length 27.5 mm DS M10x1 mm, sensor length 38 mm Pocket short $\varnothing$ 5.2x45 mm Pocket long $\varnothing$ 6x100 mm Pocket long $\varnothing$ 6x150 mm

**Flow measuring section**

Function data	
Temperature range (national approvals may differ)	5...130 °C
Recommended temperature range <ul style="list-style-type: none"> <li>● Heating</li> <li>● Cooling</li> </ul>	10...130 °C 5...50 °C
Rated pressure	1.6 MPa (PN 16; PS 16)/2.5 MPa (PN 25; PS 25)
Mounting position	Any
Mounting location	Return

Nominal flow $q_p$	Installation length	Connection	Maximum flow $q_s$	Minimum flow $q_i$	Response threshold (variable)	Pressure loss at $q_p$	Kv flow rate at $\Delta p$ 1 bar	Kv flow rate at $\Delta p$ 100 mbar	Weight
m <sub>3</sub> /h	mm	G/DN	m <sub>3</sub> /h	l/h	l/h	mbar	m <sub>3</sub> /h	m <sub>3</sub> /h	kg
0.6	110	G ¾	1.2	6	2.4	150	1.5	0,5	1
0.6	190	G 1	1.2	6	2.4	150	1.5	0.5	1.5
0.6	190	DN20	1.2	6	2.4	150	1.5	0.5	3
1.5	110	G ¾	3	15	6	150	3.9	1.2	1
1.5	130	G 1	3	15	6	160	3.8	1.2	1.5
1.5	190	G 1	3	15	6	160	3.8	1.2	1,5
1,5	190	DN20	3	15	6	160	3.8	1.2	3
2.5	130	G 1	5	25	10	200	5,6	1.8	1.5
2.5	190	G 1	5	25	10	210	5.3	1.7	1.5
2.5	190	DN20	5	25	10	210	5.3	1.7	3
3.5	260	G1¼	7	35	14	55	15	4.7	3
3.5	260	DN25	7	35	14	55	15	4.7	5
6	150	G1¼	12	60	24	190	14	4.4	3
6	260	G1¼	12	60	24	140	16	5.1	3
6	260	DN25	12	60	24	140	16	5.1	5
10	200	G 2	20	100	40	130	28	8.8	2.6
10	300	G 2	20	100	40	110	30	9.5	4
10	300	DN40	20	100	40	130	28	8.8	7
15	200	DN50	30	150	60	95	49	15.4	5
15	270	DN50	30	150	60	110	45	14.3	8
25	300	DN65	50	250	100	105	77	24.4	11
40	300	DN80	80	400	160	160	100	31.6	13
60	360	DN100	120	600	240	115	177	56.0	22
150	500	DN150	300	1500	600	120	433	136.9	50 *)

\*) Measuring insert 4 kg  
Tolerance in the event of pressure drop: +/- 5%

### Power supply optional

Standard battery WZU-BA+GUM	
Standard battery	
<ul style="list-style-type: none"> <li>Battery type</li> <li>Battery voltage</li> <li>Battery life</li> </ul>	2 AA lithium batteries (Li-SOCI2) 3.6 V At least 6 years

Universal battery WZU-BDS	
Universal battery	
<ul style="list-style-type: none"> <li>Battery type</li> <li>Battery voltage</li> <li>Battery life</li> </ul>	1 D-cell lithium battery (Li-SOCI2) 3.6 V 6...16 years (depending on configuration)

**Power pack AC 110/230 V****WZU-AC110/230-15 \*)****WZU-AC110/230-50 \*)**

Power pack AC 110/230 V

• Protection class	II
• Voltage range	AC 100 to 240 V
• Frequency	50/60 Hz
• Maximum power consumption	2.5 VA
• Overvoltage category II per EN 61010-1	CAT 2
• Length of connecting cable	1.5 m/5 m
• External fusing of supply line	Automatic cutout 6 A
• Backup time in the event of power failure	≥4 h

\*) The power pack has two outputs. One supplies the meters; the other an optional plug-in GPRS module.

**Power pack AC/DC 24 V****WZU-ACDC24-50**

Power pack AC/DC 24 V

• Protection class	III (SELV)
• Power supply	AC 12...35 V or DC 12...50 V
• Frequency	50/60 Hz or DC
• Maximum power consumption	2.5 W
• Terminals	2x 1.0 mm <sup>2</sup>
• For connecting line	Ø 5...6 mm
• Backup time in the event of power failure	>20 minutes

**Communication****Pulse module****WZU-P2**

Pulse outputs

• Number of outputs per module	2
• Standard pulses	For energy, volume and tariff register
– Pulse value	1 kWh, 10 kWh, 1 MJ, 10 MJ, 100 MJ, 0.1 m <sup>3</sup> , 1 m <sup>3</sup> per pulse
– Pulse length	100 ms conducting
– Period duration	>200 ms
• Pulse for operating states	
– Pulse duration for "Ready"	0.1...0.25 ms conducting
– Pulse duration for "Fault"	Constantly non-conducting
– Period duration	500 ms
• Fast pulses	If 1 pulse module is fitted
– Pulse length	2...100 ms in increments of 1 ms
– Max. pulse frequency	33 Hz
• Fast pulses	If 2 pulse modules are fitted
– Pulse length	5...100 ms in increments of 5 ms
– Max. pulse frequency	33 Hz

<b>Pulse module WZU-P2</b>	
<ul style="list-style-type: none"> <li>• Type</li> <li>• Voltage</li> <li>• Current</li> <li>• Classification per EN 1434-2 <ul style="list-style-type: none"> <li>– Voltage drop</li> </ul> </li> <li>• Classification per EN 1434-2 <ul style="list-style-type: none"> <li>– Voltage drop</li> </ul> </li> </ul> Dielectric strength	Open collector Max. DC 30 V Max. 30 mA OB Approx. 1.3 V at 20 mA OC Approx. 0.3 V at 0.1 mA 500 V <sub>eff</sub> against ground

<b>M-bus module WZU-MB G4 WZU-MI</b>	
M-bus slave interface <ul style="list-style-type: none"> <li>• Voltage</li> <li>• Power consumption</li> <li>• Address</li> <li>• Baud rate</li> <li>• Polarity</li> <li>• Galvanic isolation <ul style="list-style-type: none"> <li>– From meter</li> <li>– From pulse inputs</li> </ul> </li> </ul>	As per EN 1434-3 and EN 13757-2 /-3 Max. DC 50 V 1 M-bus load (1.5 mA) Primary or secondary 300, 1200, 2400, 4800, 9600 baud Any Yes No

<b>M-bus module WZU-MI Part of pulse input</b>	
Pulse inputs <ul style="list-style-type: none"> <li>• Number of inputs</li> <li>• Module battery <ul style="list-style-type: none"> <li>– Battery type</li> <li>– Battery voltage</li> <li>– Battery life</li> </ul> </li> <li>• Pulse duration (Low)</li> <li>• Pulse duration (High)</li> <li>• Frequency</li> <li>• Polarity</li> <li>• Galvanic isolation <ul style="list-style-type: none"> <li>– From meter</li> <li>– From M-bus inputs</li> </ul> </li> <li>• Pulse value</li> <li>• Display</li> <li>• Output voltage</li> <li>• Internal resistance</li> </ul>	As per EN 1434-2, class IB 2 1 BR2477A (LiCF) 3 V Operating: Up to 5 years Storage time: +1 year <small>SEP</small> If M-bus voltage is fed to the module for at least 90% of the operating time, battery life is extended to 10 years ≥50 ms ≥50 ms Max. 10 Hz Yes Yes No 0.01 to 10,000.00 liters per pulse In increments of 0.01 liter per pulse In m3, 7 digits, without or with 1 decimal place, depending on parameter setting Approx. 3.3 V Approx. 1 MΩ Approx. 3 μA



<b>M-bus module WZU-MI</b>	
<b>Part of pulse input</b>	
<ul style="list-style-type: none"> <li>• Source current</li> <li>• Pulse input closed (Low) <ul style="list-style-type: none"> <li>– Switching threshold low</li> <li>– Resistance</li> </ul> </li> <li>• Pulse input open (High) <ul style="list-style-type: none"> <li>– Switching threshold high</li> <li>– Resistance</li> </ul> </li> <li>• Max. cable length</li> </ul>	<p>&lt;0.2 V &lt;50 kΩ</p> <p>Collector not fully activated ≥6 MΩ 10 m</p>

<b>BACnet module</b>	
<b>WZU-485E-BAC</b>	
<ul style="list-style-type: none"> <li>• Communication protocol</li> <li>• Supported services</li> <li>• BACnet™ address range</li> <li>• Transmission rate</li> <li>• Data update</li> <li>• HW network connection</li> <li>• RS-485 terminating resistance</li> <li>• Alternating current</li> <li>• Direct current</li> <li>• Power consumption</li> <li>• Recommended fusing</li> <li>• Galvanic isolation <ul style="list-style-type: none"> <li>– From meter:</li> <li>– From the RS-485 network</li> </ul> </li> </ul>	<p>BACnet MS/TP (RS-485) per ASHRAE 135 and ISO 16484-5</p> <p>BACnet Application Specific Controller (B-ASC), BACnet Master Mode</p> <p>1 ... 127</p> <p>9600 to 76800 bps Default: 38400 bps Standby: 60 min. Operating: After each query, max. every 10 seconds</p> <p>Protected against short overload User external resistance (=&gt; 120 Ω)</p> <p>AC 16 ... 28 V DC 10 ... 32 V &lt; 50 mA (typically &lt; 20 mA at 24 V)</p> <p>100 mA, slow</p> <p>Yes No</p>

<b>Modbus module</b>	
<b>WZU-485E-MOD</b>	
<ul style="list-style-type: none"> <li>• Communication protocol</li> <li>• ModBus® address range</li> <li>• Transmission rate</li> <li>• Modbus parity</li> <li>• Data update</li> <li>• HW network connection</li> <li>• RS-485 terminating resistance</li> <li>• Alternating current</li> <li>• Direct current</li> <li>• Power consumption</li> <li>• Recommended fusing</li> </ul>	<p>Modbus RTU5</p> <p>0 ... 247</p> <p>2400 to 19200 bps Default: 9600 bps</p> <p>Even</p> <p>Standby: 60 min. Operating: After each query, max. every 10 seconds</p> <p>Protected against short overload User external resistance (=&gt; 120 Ω)</p> <p>AC 16 ... 28 V DC 10 ... 32 V &lt; 50 mA (typically &lt; 20 mA at 24 V)</p> <p>100 mA, slow</p>

<b>Modbus module WZU-485E-MOD</b>	
<ul style="list-style-type: none"> <li>• Galvanic isolation               <ul style="list-style-type: none"> <li>– From meter: Yes</li> <li>– From the RS-485 network: No</li> </ul> </li> </ul>	

<b>Analog module WZU-AM</b>	
Analog outputs <ul style="list-style-type: none"> <li>• Number of outputs: 2</li> <li>• Output variable: Current or voltage configurable</li> <li>• Max. load at current output: 300 Ω</li> <li>• Max. load at voltage output: 2 kΩ</li> <li>• Precision: ≤ ±} 1% of parameterized max. value</li> <li>• Max. cable length: 100 m</li> <li>• Cable cross-section: Max. 1.5 mm<sup>2</sup></li> <li>• Outputs short-circuit proof: Yes</li> <li>• Galvanic isolation from meter: Yes</li> </ul> External power supply <ul style="list-style-type: none"> <li>• Voltage range: AC 12...30 V or DC 12...42 V</li> <li>• Power consumption: Max. 170 mA at 12 V</li> <li>• Power consumption: Max. 2 VA</li> </ul> External fuse (not enclosed) <ul style="list-style-type: none"> <li>• &lt; AC/DC 24 V: 200 mA, slow</li> <li>• ≥ AC/DC 24 V: 100 mA, slow</li> <li>• Breaking capacity: 35 A (L)</li> </ul>	

<b>RF module, 868 MHz WZU-RF, WZU-RF-EXT</b>	
RF interface <ul style="list-style-type: none"> <li>• Transmission frequency: 868.95 MHz</li> <li>• Transmitter power: 3.16...25 mW</li> <li>• Receive frequency: 868.30 MHz</li> <li>• Antenna: Integrated on WZU-RF, external on WZU-RF-EXT</li> <li>• RF protocol: OMS-/DSMR compliant data transmission</li> <li>• Range: Max. 400 m/typically 30 m in buildings</li> </ul>	

<b>RF module, 868 MHz</b>	
<b>WZU-LoRa/WZU-LoRa-EXT</b>	
<ul style="list-style-type: none"> <li>● Transmission frequency</li> <li>● Transmitter power (ERP)</li> <li>● Range*) <ul style="list-style-type: none"> <li>– Free field of view</li> <li>– In buildings</li> </ul> </li> <li>● Power supply Via meter **) <ul style="list-style-type: none"> <li>– Power is supplied with a power supply</li> </ul> </li> <li>● Meets the standard</li> </ul> <p>*) Can differ significantly depending on the building structure.</p> <p>**) Replace by type D if another battery is installed. The battery life applies for standard data telegrams (content similar to P600) as well as UH50.. at the default measuring interval for flow and temperature.</p>	<p>868 MHz</p> <p>25 mW (14 dBm)</p> <p>10 km</p> <p>100 m</p> <p>Battery type D</p> <p>Transmission interval: 60 minutes, service life: 11 years</p> <p>Transmission interval: 160 minutes, service life: 16 years</p> <p>110/230/24 V (not with Elvaco: 24 V)</p> <p>LoRaWAN Version 1.0 (Class A bi-directional)</p>

<b>GPRS module</b>	
<b>WZU-GPRS</b>	
<b>WZU-GPRS-ANT</b>	
<p>GPRS interface</p> <ul style="list-style-type: none"> <li>● Band</li> <li>● External antenna</li> <li>● Logs</li> <li>● Configuration</li> <li>● Backup real-time clock</li> <li>● Max. humidity in operation <ul style="list-style-type: none"> <li>– Power supply</li> <li>– Voltage range</li> <li>– Frequency</li> <li>– Power consumption</li> <li>– Rated consumption</li> <li>– Overvoltage category per EN 61010-1</li> </ul> </li> </ul>	<p>Class 12</p> <p>850/900/1,800/1,900 MHz</p> <p>WZU-GPRS with magnetic base</p> <p>WZU-GPRS-ANT with screwed connection</p> <p>Email over SMTP</p> <p>Passive FTP mode</p> <p>HTTP POST and GET</p> <p>GMS data transparent M-bus</p> <p>TCP transparent M-bus</p> <p>SMS, HTTP, FTP, GSM CSD</p> <p>12 h</p> <p>80% r.h.</p> <p>Enclosed with module:</p> <p>AC 100...240 V -20%...+15%</p> <p>50/60 Hz</p> <p>&lt; 6 W</p> <p>&lt; 1 W</p> <p>II</p>

<b>GPRS module WZU-GPRS</b>	
<b>M-bus master</b>	
M-bus master interface	As per EN 13757
<ul style="list-style-type: none"> <li>• Baud rate</li> </ul>	2400 and 9600 baud
<ul style="list-style-type: none"> <li>• Number of M-bus slaves</li> </ul>	Max. 8
<ul style="list-style-type: none"> <li>• Line length</li> </ul>	Max. 1000
<ul style="list-style-type: none"> <li>• Technical design</li> </ul>	2-wire connection, interchangeable

<b>Housing type</b>	
Protection class	II as per EN 61010-1
Degree of protection processor unit	IP54

<b>Ambient conditions</b>			
	<b>Operation</b> EN 60721-3-3	<b>Transportation</b> EN 60721-3-2	<b>Storage</b> EN 60721-3-1
Climatic conditions	Class A	Class A	Class A
Temperature	5...55 °C-	20...60 °C	20...60 °C
Humidity	<93% r.h. at 25 °C (non-condensing)	<93% r.h. at 25 °C (non-condensing)	<93% r.h. at 25 °C (non-condensing)
Mechanical conditions	Class M1	Class M1	Class M1
Max. altitude	Min. 700 hPa, corresponding to max. 2,000 m above sea level		

<b>Standards, directives and approvals</b>	
Product standards	DIN EN 1434-x (heat/cooling energy meters)
EU conformity (CE)	CE2T5324xx *)
RCM Conformity	CE2T5372en_C1 *)

<b>Environmental compatibility</b>
The product environmental declaration 8000079744 *) contains data on environmentally compatible product design and assessments (RoHS compliance, materials composition, packaging, environmental benefit, disposal).

<b>Dimensions</b>	
(W x H x D):	
<ul style="list-style-type: none"> <li>• Processor unit</li> </ul>	143 x 136 x 42 mm
<ul style="list-style-type: none"> <li>• Flow measuring section</li> </ul>	See "Dimensions"

<b>Housing material</b>	
Cover	PC
Bottom section	PC-GF10

<b>Housing colors</b>	
Cover	Front crystal-clear, logo PEs plastic foil, RAL 7035 and RAL 5014
Bottom section	RAL 9002

\*) The documents can be downloaded at <http://siemens.com/bt/download>.

## Dimensions

Dimensions in mm

### Processor unit

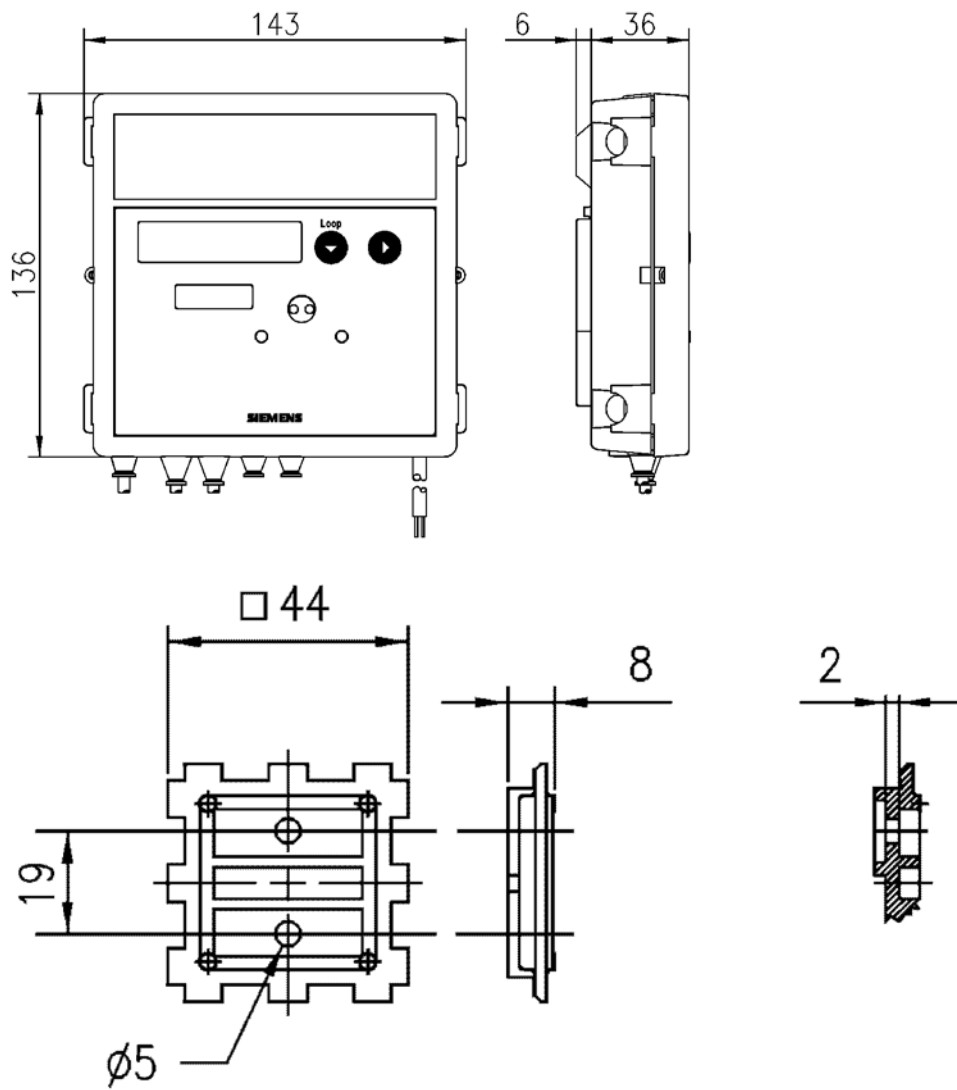

Adapter plate

Cross-sectional area

**Flow measuring section  
0.6...2.5 m<sup>3</sup>/h**

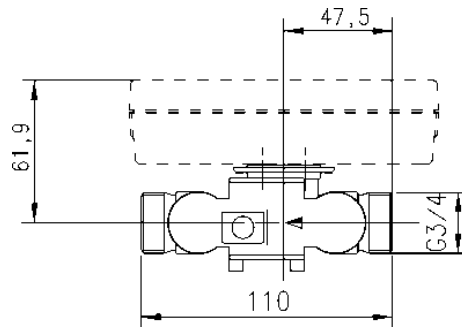

Mounting length 110 mm (threaded)

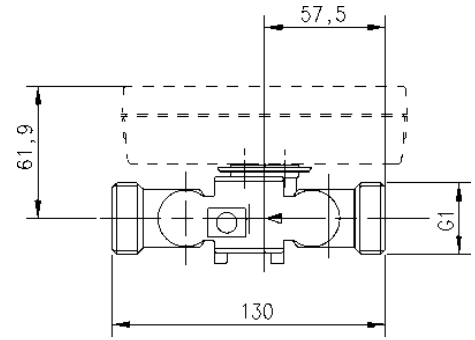

Mounting length 130 mm (threaded)

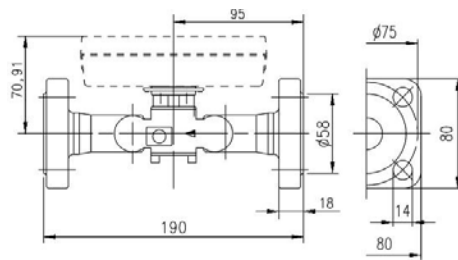

Mounting length 190 mm (flanged)

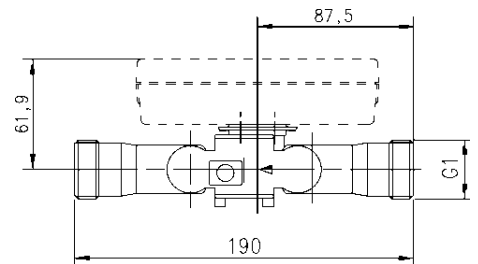

Mounting length 190 mm (threaded)

**Flow measuring section as of 3.5 m<sup>3</sup>/h**

**with threaded connection**

Alternative mounting options

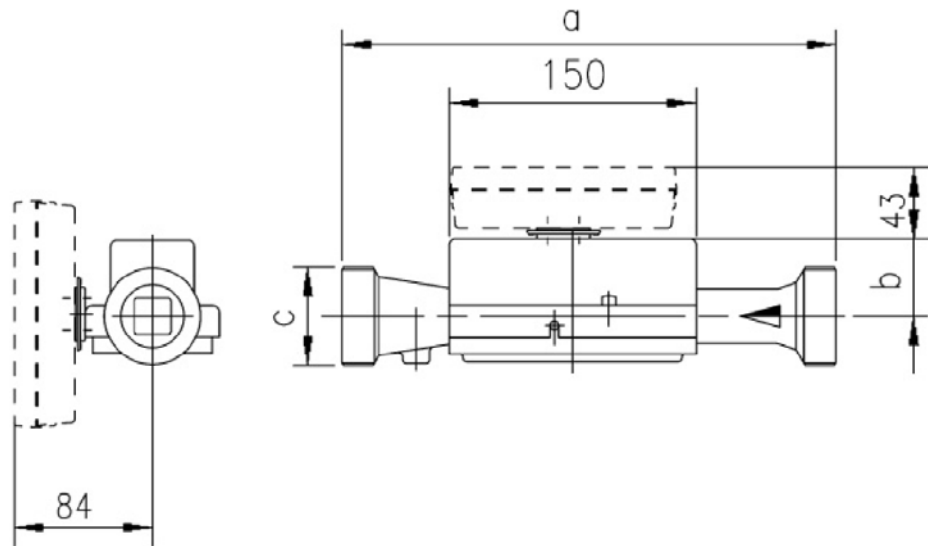

Product no.	qp m³/h	PN bar	a	b	c
UH50-x45	3.5	16	260	51	G11/4
UH50-x47		25			
UH50-x50	6	16	260	51	G11/4
UH50-x60	10	16	300	48	G2
UH50-x63		16	200		

### Flow measuring section as of 3.5 m³/h

#### Flanged

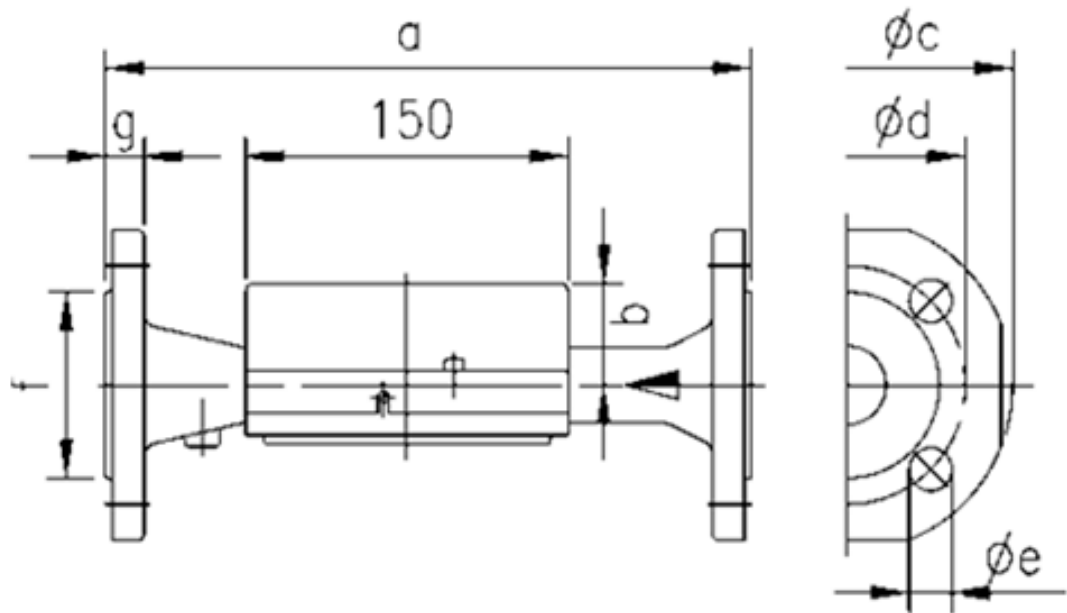

Product no.	qp m³/h	PN bar	DN	a	b	Øc	Ød	Øe	Number of holes	f	g
UH50-x46	3.5	25	25	260	51	115	85	14	4	68	18
UH50-x52	6	25	25	260	51	115	85	14	4	68	18
UH50-x61	10	25	40	300	48	150	110	18	4	88	18
UH50-x65	15	25	50	270	46	165	125	18	4	102	20
UH50-x69				200							
UH50-x70	25	25	65	300	52	185	145	18	8	122	22
UH50-x74	40	25	80	300	56	200	160	18	8	138	24
UH50-x82	60	16	100	360	68	235	180	18	8	158	24
UH50-x83	60	25	100	360	68	235	190	22	8	158	24



Large meter  $q_p$  150

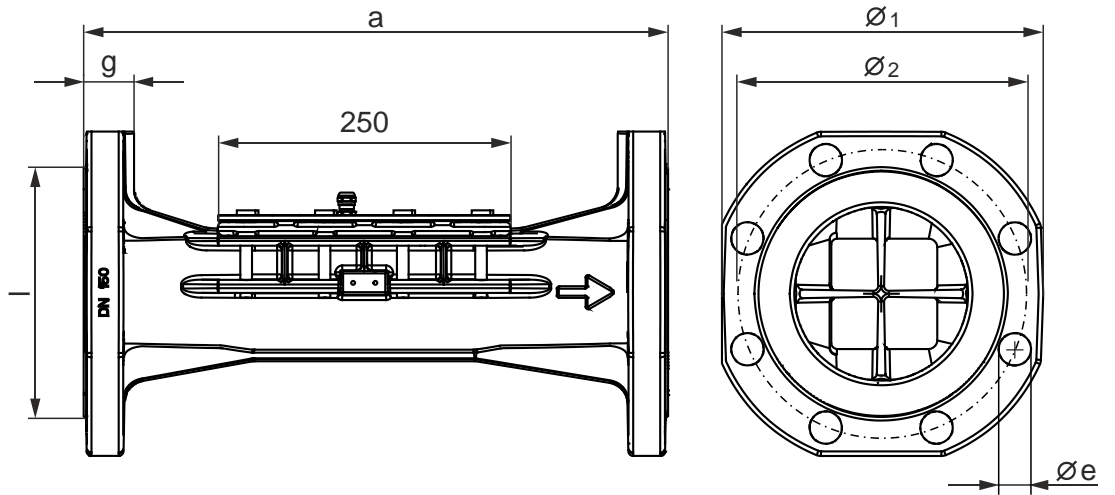

Product no.	$q_p$ m <sup>3</sup> /h	PN bar	DN	a	b	Øc	Ød	Øe	Number of holes	f	g
UH50-xA1	150	16	150	500	91	300	240	23	8	211	31
UH50-xA2	150	25	150	500	91	300	250	28	8	211	31

Issued by  
Siemens Switzerland Ltd  
Smart Infrastructure  
Global Headquarters  
Theilerstrasse 1a  
CH-6300 Zug  
Tel. +41 58 724 2424  
[www.siemens.com/buildingtechnologies](http://www.siemens.com/buildingtechnologies)

© Siemens Switzerland Ltd, 2012  
Technical specifications and availability subject to change without notice.