



ACVATIX™

Electromotive actuators for **SQV..P..** combi valves

For combi valves VPF43.. and VPF53..

- **SQV91..** Operating voltage AC/DC 24 V,
Positioning signal 3-position, DC 0-10 V, DC 4-20 mA
- Position feedback and selection of flow characteristic
- Manual adjuster, position and status indication (LED)
- Selectable positioning times 40-240 seconds
- Fail-safe function (combi valve open/closed)
- Selection of acting direction
- Optional functional extension: Auxiliary switch, potentiometer, and AC 230 V module
- Direct mounting on combi valves
- UL Listed

Use

Electromotive actuators to operate Siemens combi valves for type series VPF43.. and VPF53.. with 20/40/43 mm stroke, as control valves for ventilation, air conditioning, district heating and refrigeration plants.

Type summary

Type	Stock No.	Stroke	Pos. force	Operating voltage	Positioning signal	Spring return time	Pos. time ²⁾		Fail-safe function
							20mm	40mm	
SQV91P30	S55150-A130	20/40/43 mm	1100 N	AC/DC 24 V AC 230 V ¹⁾	3-position DC 0...10 V DC 4...20 mA	30 sec	40 sec	80 s	Stem retracts
SQV91P40	S55150-A131						60 sec	120 s	
							90 sec	180 s	Stem extends
							120 sec	240 s	

¹⁾ AC 230 V requires accessory ASP1.1.

²⁾ The positioning time can be selected using the DIL switch, see page 7.

Electrical accessories

Type	Auxiliary switch pair ASC10.42	Potentiometer ASZ7.6/1000	AC 230 V module ASP1.1
Stock number	S55845-Z137	S55845-Z136	S55845-Z138
	Max. 2		
SQV91P30	Max. 1		Max. 1
SQV91P40	Max. 1		Max. 1

Spare parts, rev. number

No spare parts available.
Revision numbers, see page 13.

Ordering

Example

Type	Stock number	Designation	Quantity
SQV91P40	S55150-A131	Actuator	1
ASZ7.6/1000	S55845-Z136	Potentiometer	1

Delivery

Actuator, combi valve, and accessories are individually packed for delivery.

Equipment combination

Valve type	DN	PN class	Flow V_{100} [m ³ /h]	Data sheet
 Combi valves				
VPF43..	Flange	16	2,3...25	N4315
			4,4...35	
			5,3...43	
			12,1...90	
			18,5...135	
			25,6...195	
VPF53..	Flange	25	2,3...25	N4316
			4,4...35	
			5,3...43	
			12,1...90	
			18,5...135	
			25,6...195	

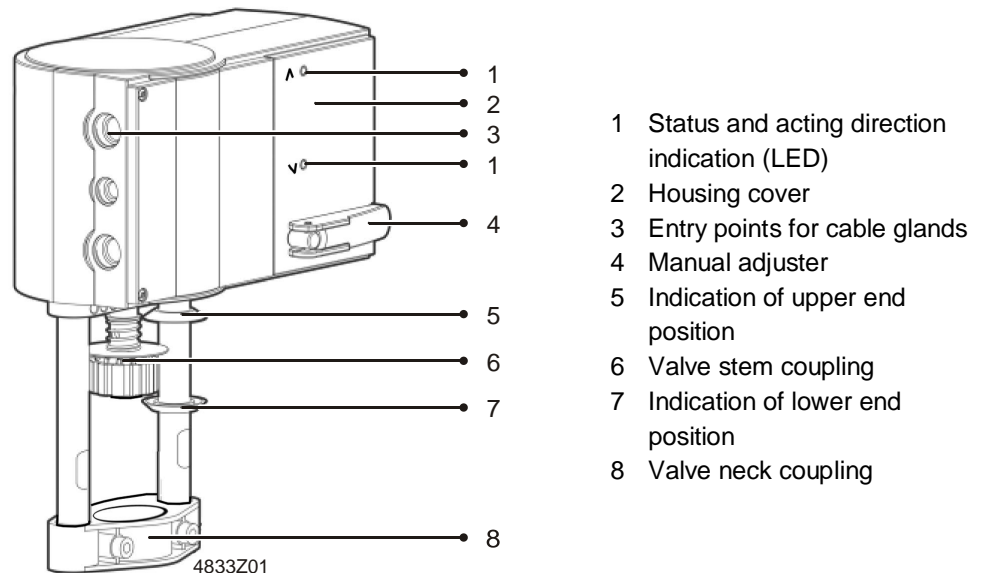

- 1 Status and acting direction indication (LED)
- 2 Housing cover
- 3 Entry points for cable glands
- 4 Manual adjuster
- 5 Indication of upper end position
- 6 Valve stem coupling
- 7 Indication of lower end position
- 8 Valve neck coupling

The actuator can be operated as a 3-position or modulating actuator in two acting directions depending on the type of connection. It is suitable for both combi valves VPF.. with 20 mm stroke as well as for valves with a 40 mm and 43 mm stroke. The stroke is calibrated automatically during initialization.

The actuator includes a position feedback.

The actuator travels to the end position in the event of power loss, see "Fail-safe function", page 5. Up to 45 seconds pass until the actuator is available again following a restart or start after the fail-safe function is triggered.

The positioning time (40 to 240 seconds) and the flow characteristic (lin/log) can be set via the DIL switches.

Auto mode

The manual adjuster is disengaged.

Manual mode

The manual adjuster allows for manually setting the position. The motor is switched off when the manual adjuster is engaged. The fail-safe function (spring return) is reactivated after the manual adjuster is disengaged, and the actuator travels again to the set position without calibration.

The actuator remains in this position without active operating voltage for as long as the manual adjuster is engaged.

Initialization, automatic coupling, calibration

The actuator independently calibrates itself for each type of connection. Initialization occurs as soon as operating voltage is supplied for the first time and the waiting period ends. The actuator travels to the lower stop of the combi valve, thus enabling automatic coupling with the valve stem. It then travels to the upper stop, records and stores it. Recalibration can be manually triggered any time, see "Recalibration", page 5.

3-position control signal

The combi valve can travel to any position by supplying voltage to terminal G1 or G2 as well as L1¹⁾ or L2¹⁾.

- Voltage on G2, L2: Actuator stem retracts, combi valve opens.
- Voltage on G1, L1: Actuator stem extends, combi valve closes.
- No voltage on G1 and G2: Actuator stem stays at the applicable position.
or L1 and L2:

¹⁾ When using the AC 230 V module ASP1.1.

Changeover of acting direction

Direct acting

The acting direction of the stroke direction can be reversed by exchanging connections G1 and G2 or L1 and L2.

Reverse acting

Positioning signal OPEN on G2, L2. Positioning signal CLOSED on G1, L1.
Positioning signal OPEN on G1, L1. Positioning signal CLOSED on G2, L2.

Notes

- Do not use connection Yu (DC 0-10 V) and Yi (DC 4-20 mA).
- Positioning times can be selected, see "Positioning times", page 7".
- Valve characteristic curves "lin" or "log" cannot be selected.
- Position feedback U is activated after initialization/calibration.

Electronic motor shutdown is triggered in the end positions (valve stop or upon reaching maximum stroke) or by overload (no end switch).

Positioning signals Yu and Yi

DC 0-10 V (Yu)

DC4-20 mA (Yi)

The combi valve can be driven to any position by connecting a continuous positioning signal Yu or Yi. The acting direction can be reserved (direct/reverse acting) by connecting operating voltage to G1 or G2:

Direct acting

Operating voltage AC/DC 24 V on G1 or AC 230 V on L1

- Pos. signal to Yu, Yi increasing: Actuator stem retracts, combi valve opens.
- Pos. signal to Yu, Yi decreasing: Actuator stem extends, valve closes.
- Pos. signal to Yu, Yi continuous: Actuator stem remains in the respective pos.

Reverse acting

Operating voltage AC/DC 24 V on G2 or AC 230 V on L2

- Pos. signal to Yu, Yi increasing: Actuator stem extends, combi valve closes.
- Pos. signal to Yu, Yi decreasing: Actuator stem retracts, combi valve opens.
- Pos. signal to Yu, Yi continuous: Actuator stem remains in the respective pos.

Acting direction

Direct acting

Reverse acting

Position signal	Operating voltage	Actuator stem	Combi valve
Yu, Yi increasing	G1 to AC/DC 24 V L1 to AC 230 V	Retracts	Opens
Yu, Yi increasing	G2 to AC/DC 24 V L2 to AC 230 V	Extends	Closes

Notes

- The input with the higher value has priority when a positioning signal is available at both Yu and Yi.
- When using the AC 230 V module ASP1.1, the SQV..P can also be operated with a DC 0...10 V or DC 4...20 mA positioning signal.
- The actuator travels to the applicable end position depending on the selected acting direction if Yu or Yi are interrupted:
 - Operating voltage to G1 or L1 Actuator stem extends.
 - Operating voltage to G2 or L2 Actuator stem retracts.
- Positioning times can be selected, see "Positioning times", page 7".
- Valve characteristic curves "lin" or "log" can be selected.
- Position feedback U is activated after initialization/calibration.
- Parallel operation with up to 5 actuators possible, see "**Fehler! Verweisquelle konnte nicht gefunden werden.**", page **Fehler! Textmarke nicht definiert.**

Position feedback U

Position feedback U (DC 0...10 V) is always proportional to stroke H for the actuator. It is also active when using the AC 230 V module ASP1.1.

DIL switch	Flow characteristics	Position feedback U
lin = linear ¹⁾		
log = equal percentage, n _{gl} = 3 (logarithmic normal)		
log = equal percentage, n _{gl} = 3 (exponential normal)		

¹⁾ Factory setting

Fail-safe function

The actuator travels to the applicable end position (the stem retracts or extends depending on the model) using the preloaded spring if operating voltage to terminal G or 21 is lost or shut down. In this case, the actuator's control function is locked for 45 seconds (both LEDs are green) to reach the end position at any rate. There is no recalibration. The reset positioning speed ensures that no pressure surges occur in the piping.

End position	SQV91P30 Actuator stem retracted	Combi valve opened (V = 100%).
	SQV91P40 Actuator stem extended	Combi valve closed (V = 0%).

Recalibration

Recalibration can be manually triggered any time.

1. Operating voltage is supplied.
2. Engage and disengage the manual adjuster twice within 4 seconds.
3. Both LEDs flash green.
4. Recalibration is successful when both LEDs are lit green.
5. Return to normal control function.

Notes

- Position feedback U is inactive or corresponds to value "0".
- The shortest possible runtime is initialized.
- Recalibration is valid only after the entire process is completed.
- Additional engaging the manual adjuster interrupts the process.

Blockade detection

The valve actuator indicates detected blockage by setting the feedback signal to 0 V after ca. 90 seconds. The actuator, however, tries to overcome the blockage during this period. Normal control function is reactivated if the blockage is overcome and position feedback U is once again available.

Response at the end positions

Blockade detection is always operational. In other words, the actuator demonstrates the following response at end positions H_{100} and H_0 not only during initialization and calibration, but also during normal control operation:

1. The actuator travels to the end position; the LED is lit in the direction of travel.
2. It detects the end position; both LEDs are lit green.
3. It then briefly travels in the opposite direction; the LED is lit in the direction of travel.
4. It then returns to the end position; LED is lit in the direction of travel
5. It detects the end position; both LEDs are lit green.

This response is repeated with time intervals between travels increasing exponentially. The intervals are:

- 25 seconds
- 1 min 40 seconds
- 6 min 40 seconds
- 26 min
- 1 h 46 min 40 seconds
- 7 h 6 min 40 seconds
- 1 day 4 h 26 min 40 seconds

for the previous interval.

Status and acting direction indication (LED)

The status and acting direction indication consists of two green, lit LEDs.



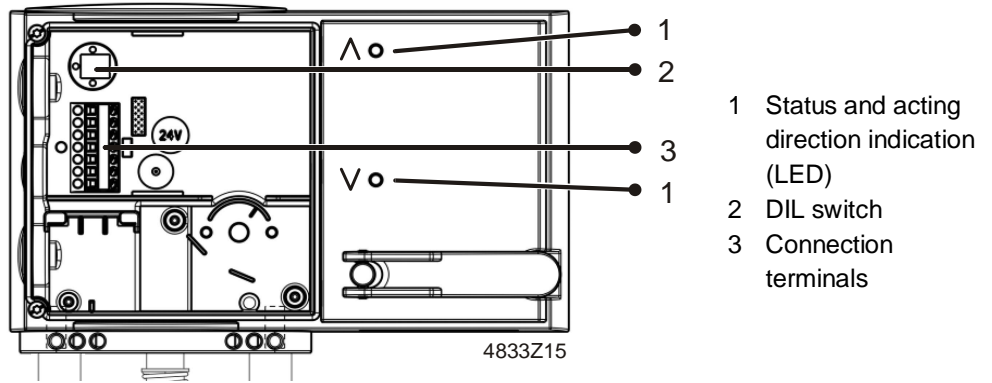

Indication		Function
4833Z08	<ul style="list-style-type: none"> ▪ LED flashes green ▪ LED flashes green 	<ul style="list-style-type: none"> ▪ Initialization. ▪ Manual mode. ▪ Delay after operating voltage is supplied, or the fail-safe function is triggered.
4833Z09	<ul style="list-style-type: none"> ▪ Steady green ▪ -- 	Actuator stem retracts.
4833Z10	<ul style="list-style-type: none"> ▪ -- ▪ Steady green 	Actuator stem extends.
4833Z11	<ul style="list-style-type: none"> ▪ Steady green ▪ Steady green 	End position reached.
4833Z12	<ul style="list-style-type: none"> ▪ LED flashes green ▪ -- 	Blockage or foreign object detected during retraction.
4833Z13	<ul style="list-style-type: none"> ▪ -- ▪ LED flashes green 	Blockage or foreign object detected during extension.
4833Z14	<ul style="list-style-type: none"> ▪ -- ▪ -- 	No operating voltage

Frost protection thermostat.

The actuators can be operated using a frost protection thermostat or temperature detector, see "Connection diagrams", page 11.



DIL switch
Positioning times





DIL switch	Speed	Positioning time ¹⁾	
		20 mm	40 mm
	2 sec/mm	40 sec ²⁾	80 sec ²⁾
	3 sec/mm	60 sec	120 sec
	4,5 sec/mm	90 sec	180 sec
	6 sec/mm	120 sec	240 sec

¹⁾ Tolerance: ± 1 sec

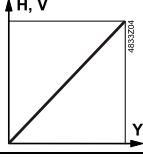

²⁾ Factory setting

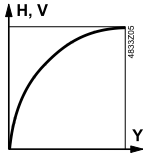
DIL switch
Flow characteristics

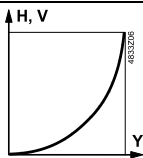
The flow characteristics can be used only for connections with constant positioning signals DC 0...10 V and DC 4...20 mA.

DIL switch	Flow characteristics	
	lin = linear ¹⁾	
 	log = equal percentage, $n_{gl} = 3$ (logarithmic normal)	
	log = equal percentage, $n_{gl} = 3$ (exponential normal)	

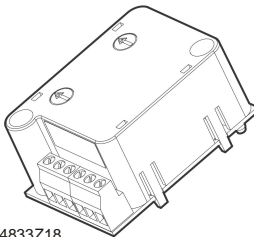
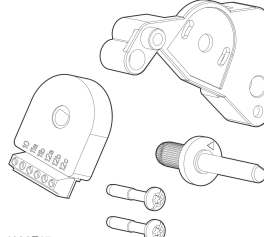
¹⁾ Factory setting

Type	ASC10.42	ASZ7.6/1000	ASP1.1
Stock no.	S55845-Z137	S55845-Z136	S55845-Z138
	Auxiliary switch pair	Potentiometer	AC 230 V module
			
	Switching points can be continuously adjusted between 0 and 100%	0...1000 Ω	AC 230 V to AC 24 V converter
Installation	Max. 1		Max. 1
	Max. 2		

See section "**Fehler! Verweisquelle konnte nicht gefunden werden.**" (page **Fehler! Textmarke nicht definiert.**) for more information.

Notes

Engineering

Install electrical connections in accordance with local regulations on electric installations as well as internal or connecting diagrams as of page 10.

Observe safety regulations and restrictions designed to ensure the safety of people and property at all times!

- An internal controller controls the actuator for 3-position or DC 4...20 mA positioning signal connection types, see "Connection diagrams", page 11.
- For DC 0...10 V connections (input impedance $R_i = 100 \text{ k}\Omega$), up to 5 actuators can be controlled in parallel by a controller with a rating of 1 mA.
- The switching points must be entered on the plant diagram when using the double auxiliary switch ASC10.42.
- Do not insulate the actuator console and valve stem, as air circulation must be ensured.
- **Non-observance of the above may result in accidents and fires!**
- **Do not touch the hot parts without prior protective measures to avoid burns!**
- For permitted temperatures, see "**Fehler! Verweisquelle konnte nicht gefunden werden.**", page **Fehler! Textmarke nicht definiert.**



Mounting

Mounting instructions 74 319 0821 0 on mounting combi valves are included in the actuator's packaging. Mounting instructions for accessories are located in the respective packaging.

Accessories		Mounting instructions	
ASC10.42	S55845-Z137	M4833.1	74 319 0860 0
ASZ7.6/1000	S55845-Z136	M4833.2	74 319 0861 0
ASP1.1	S55845-Z138	M4833.3	74 319 0862 0

Mounting positions

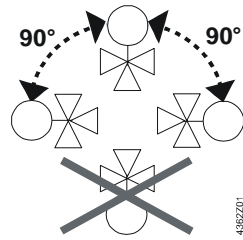

Commissioning

- Check the wiring and carry out a functional check as part of commissioning.
- Make or check the settings as per the plant diagram for auxiliary switches and potentiometers.

Maintenance

The actuators are maintenance-free.

Recommendation

- Regularly check functioning (trial) of actuators with safety functions.

When servicing the actuating device:

- Switch off both pump and operating voltage.
- Close the main shutoff valve in the piping.
- Release pressure in the pipes and allow them to cool down completely.
- Disconnect electrical connections from the terminals as needed.
- The actuator must be properly installed prior to recommissioning the valve.

Recommendation

Trigger stroke calibration after servicing.



Repair

- There are no spare parts available; the entire actuator must be replaced.
- **Removing the spring on the actuator is prohibited due to the high risk of injury.**

Disposal



The device is considered electrical and electronic equipment for disposal in terms of the applicable European Directive and may not be disposed of as domestic garbage.

- Dispose of the device through channels provided for this purpose.
- Comply with all local and currently applicable laws and regulations.

Warranty

The engineering data specified in section "Equipment combination" (page 2) are only guaranteed in connection with the Siemens valves listed.

Note

When using the actuators together with third-party valves, correct functioning must be ensured by the user, and Siemens will assume no responsibility.

Technical data

		SQV..P..
Power supply	Operating voltage	AC 24 V ± 20% DC 24 V ± 15%
	With ASP1.1 AC 230 V module	AC 230 V ± 15%
	Frequency	50...60 Hz
	Fusing ac. DIN 57100 part 430 (supply lines)	6 A...10 A slow
Function data	Power consumption	20 VA / 7,5 W
	With ASP1.1 AC 230 V module	22 VA
	Positioning times	20 mm 40 mm
	Positioning force Nominal stroke Permissible medium temperature (valve fitted)	40 1) / 60 / 90 / 180 sec 80 1) / 120 / 180 / 240 sec The positioning time depends on the DIL switch setting, "Positioning times" (page 7) 1100 N 20 mm / 40 mm / 43 mm 1...120 °C
Signal inputs	Position signal	Terminal G1, G2 Voltage
	Terminal Yu	Voltage
	Terminal Yi	Input impedance Power Input impedance
		3-position AC 24 V ± 20% DC 24 V ± 15% AC 230 V ± 15% DC 0...10 V ≥100 kΩ DC 4...20 mA 50 Ω
Fail-safe function ²⁾	Terminal G / 21	SQV91P30
		SQV91P40
	Spring return time	20 mm 40 mm
		Loss of operating voltage Actuator stem retracted, combi valve fully open (100%). Loss of operating voltage Actuator stem extended, combi valve fully closed (0%). 15 sec ³⁾ 30 sec ³⁾
Position feedback	Position feedback U	DC 0...10 V
	Load impedance Load	>2.5 kΩ res. Max. 4 mA
Connecting cable	Wire cross-sectional areas	0.75...1.5 mm ² , AWG 20...16 ⁴⁾
	Cable entry	2 entry points M20 x 1. 1 entry points M16 x 1.5
Degree of protection	Housing from vertical to horizontal	IP 66 as per EN 60529
	Insulation class	As per EN 60730
	AC / DC 24 V With ASP1.1 AC 230 V module	III II
Environmental conditions	Operation	IEC 60721-3-3
	Climatic conditions	Class 3K5
	Mounting location	Indoors (weather-protected)
	Temperature General	0...55 °C
	Humidity (non-condensing)	<95% r.h.
Transport	Climatic conditions	IEC 60721-3-2
	Temperature	Class 2K3
	Humidity	-30...70 °C <95% r.h.
Storage	Climatic conditions	IEC 60721-3-1
	Temperature Humidity	Class 1K3 -30...65 °C 5...95% r.h.
	Max. media temperature when mounted on combi valve	130 °C
Norms and directives	Electromagnetic compatibility (Application)	For residential, commercial and industrial environments
	Product standard	EN60730-x
	EU Conformity (CE)	CE1T4833xx01 ⁵⁾
	RCM Conformity	CE1T4833xx02 ⁵⁾
	UL Listed	UL 873
		23BA, 23FR, E75924 Identical to the authorized Listee's model numbers – AVF234SF232U & AVF234SF132U
Environmental compatibility		The product environmental declaration CE1E4833en ⁵⁾ contains data on environmentally compatible product design and assessments (RoHS compliance, materials composition, packaging, environmental benefit, disposal).

		SQV..P..
Dimensions		See "Dimensions" (page 13)
Accessories	Potentiometer ASZ7.6/1000	0...1000 Ω ± 20%
	Voltage Load	AC / DC 24 V
	< 1 W	
Double auxiliary switch ASC10.42	Switching capacity	AC/DC 12...AC 230 V, 6 A resistive, 2 A inductive
AC 230 V module ASP1.1	Voltage Power consumption	AC 230 V ± 5% 22 VA

- 1) Factory setting
- 2) Control function is locked for 45 seconds.
- 3) At +23 °C ambient temperature and 1100 N nominal load
- 4) AWG = American wire gauge.
- 5) The documents can be downloaded from <http://siemens.com/bt/download>

Connection diagrams

Connection diagrams

AC / DC 24 V

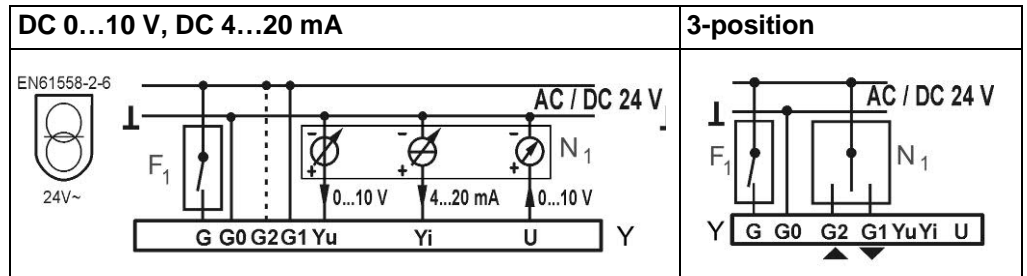

- Y1** actuator
N1 controller
F1 frost protection thermostat

AC 230 V

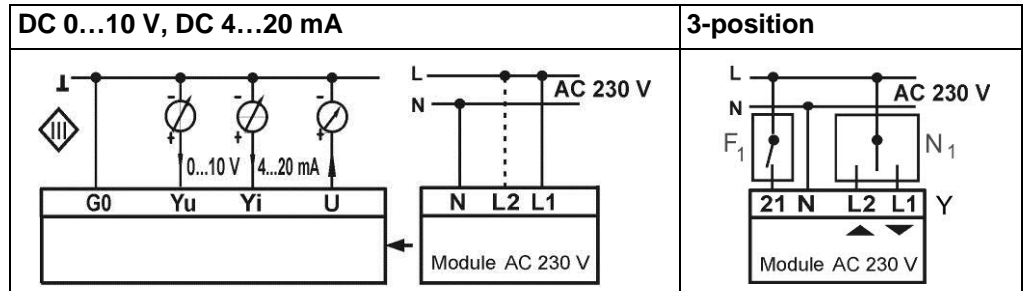

- Y1** actuator
N1 controller
F1 frost protection thermostat

Connection terminals

DC 0...10 V
DC 4...20 mA

AC / DC 24 V

G	—	Fail-safe function (system potential)
G0	—	System neutral
G2	—	AC/DC 24 V, acting direction: Actuator stem extends as the positioning signal increases ¹⁾
G1	—	AC/DC 24 V, acting direction: Actuator stem retracts as the positioning signal increases ¹⁾
Yu	—	Positioning signal DC 0...10 V
Yi	—	Positioning signal DC 4...20 mA
U	—	Position feedback DC 0...10 V

with AC 230 V module ASP1.1

AC 230 V

L1	—	AC 230 V, acting direction: Actuator stem retracts as the positioning signal increases ¹⁾
L2	—	AC 230 V, acting direction: Actuator extends as the positioning signal increases ¹⁾
N	—	Neutral
21	—	Fail-safe function (phase)
U	—	Position feedback DC 0...10 V
Yi	—	Positioning signal DC 4...20 mA
Yu	—	Positioning signal DC 0...10 V

¹⁾ Connect either G1 or G; or L1 or L2. Refer to the description at "Positioning signals Yu and Yi", page 4 for additional details.

3-position

AC / DC 24 V

G	—	Fail-safe function (system potential)
G0	—	System neutral
G2	—	AC/DC 24 V, acting direction: Actuator stem retracts, combi valves fully open (100%) ¹⁾
G1	—	AC/DC 24 V, acting direction: Actuator stem extends, combi valves fully closed (0%) ¹⁾
Yu	—	Positioning signal DC 0...10 V (not used for the 3-position operation)
Yi	—	Positioning signal DC 4...20 mA (not used for 3-position operation)
U	—	Position feedback DC 0...10 V

With AC 230 V module ASP1.1

AC 230 V

L1	—	AC 230 V, acting direction: Actuator stem extends, combi valves fully closed (0%) ¹⁾
L2	—	AC 230 V, acting direction, Actuator stem retracts, combi valve fully open (100%) ¹⁾
N	—	Neutral
21	—	Fail-safe function (phase)
U	—	Position feedback DC 0...10 V
Yi	—	Positioning signal DC 4...20 mA (not used for the 3-position operation)
Yu	—	Positioning signal DC 0...10 V (not used for 3-position operation)

¹⁾ Refer to the description at "3-position control signal", page 3 for additional details.

Dimensions

All dimensions in mm

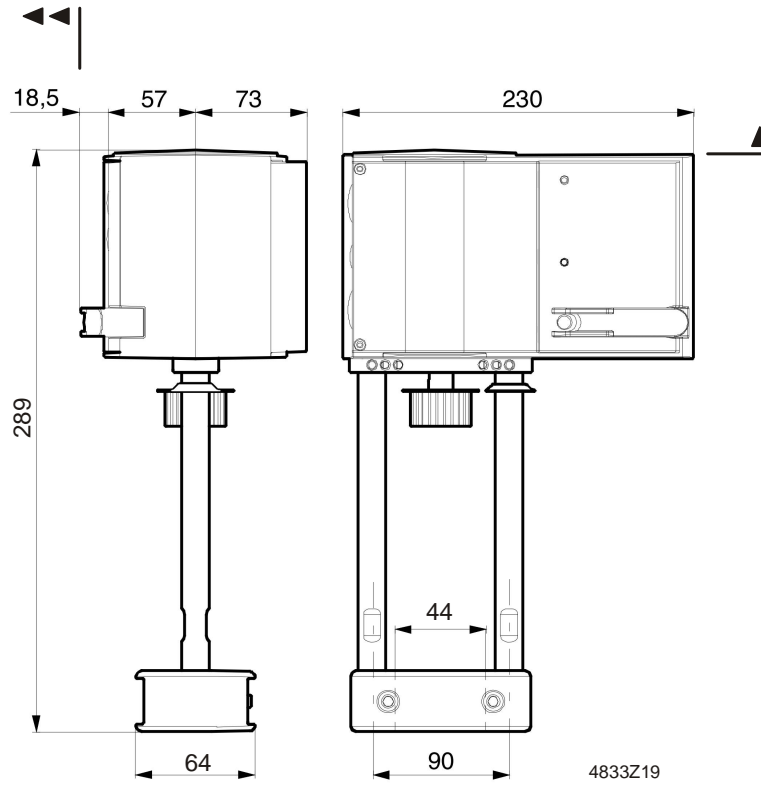

▶	> 100 mm	Minimum mounting distance to wall or ceiling, for mounting, connection, operation, maintenance etc.
▶▶	>200 mm	

Revision numbers

Type	Revision number	Type	Revision number
SQV91P30	A	SQV91P40	A

Issued by
Siemens Switzerland Ltd
Building Technologies Division
International Headquarters
Theilerstrasse 1a
6300 Zug
Switzerland
Tel. +41 58-724 24 24
www.siemens.com/buildingtechnologies

© Siemens Switzerland Ltd, 2011
Technical specifications and availability subject to change without notice.