



## Electro-hydraulic actuators for valves

with a 20 mm stroke

**SKB32..**  
**SKB82..**  
**SKB62..**  
**SKB60**

- **SKB32..** Operating voltage AC 230 V, 3-position control signal
- **SKB82..** Operating voltage AC 24 V, 3-position control signal
- **SKB6..** Operating voltage AC 24 V, control signal DC 0...10 V, 4...20 mA or 0...1000  $\Omega$
- **SKB6..** Choice of flow characteristic, position feedback, stroke calibration, LED status indication, override control
- **SKB62UA** with functions choice of direction of operation, stroke limit control, sequence control with adjustable start point and operating range, operation of frost protection monitors QAF21.. and QAF61..
- Positioning force 2800 N
- Actuator versions with or without spring-return function
- For direct mounting on valves; no adjustments required
- Manual adjuster and position indicator
- Optional functions with auxiliary switches, potentiometer, stem heater and mechanical stroke inverter
- **SKB..U** are UL-approved

## Use

For the operation of Siemens 2-port and 3-port valves, types VVF.., VVG.., VXF.. and VXG.. with a 20 mm stroke as control and safety shut-off valves in heating, ventilation and air conditioning systems.

## Types

|                      | Type                    | Operating voltage                              | Positioning signal | Spring-return |       | Positioning time |                   | Enhanced functions |
|----------------------|-------------------------|--|--------------------|---------------|-------|------------------|-------------------|--------------------|
|                      |                         |  |                    | Function      | Time  | Opening          | Closing           |                    |
| Standard electronics | SKB32.50 <sup>1)</sup>  | AC 230 V                                       | 3-position         |               |       | 120 s            | 120 s             |                    |
|                      | SKB32.51 <sup>1)</sup>  |  |                    | yes           | 10 s  |                  |                   |                    |
|                      | SKB82.50 <sup>1)</sup>  | AC 24 V  |                    |               |       | 120 s            | 10 s              |                    |
|                      | SKB82.50U <sup>2)</sup> |  |                    |               |       |                  |                   |                    |
|                      | SKB82.51 <sup>1)</sup>  |  |                    | yes           | 10 s  |                  |                   |                    |
|                      | SKB82.51U <sup>2)</sup> |  |                    |               |       |                  |                   |                    |
| Enhanced electronics | SKB62 <sup>1)</sup>     | DC 0...10 V,<br>4...20 mA,<br>or<br>0...1000 Ω | yes                | 10 s          | 120 s | 10 s             | yes <sup>3)</sup> |                    |
|                      | SKB62U <sup>2)</sup>    |  |                    |               |       |                  |                   |                    |
|                      | SKB60 <sup>1)</sup>     |  |                    |               |       |                  |                   |                    |
|                      | SKB62UA <sup>2)</sup>   |  | yes                | 10 s          |       |                  |                   |                    |

<sup>1)</sup> Approbation: CE

<sup>2)</sup> Approbation: CE, UL

<sup>3)</sup> Direction of operation, stroke limit control, sequence control, signal addition

## Accessories

| Type   | Description                | For actuator | Mounting location |
|--------|----------------------------|--------------|-------------------|
| ASC1.6 | Auxiliary switch           | SKB6..       | 1 x ASC 1.6       |
| ASC9.3 | Dual auxiliary switches    | SKB32..      | 1 x ASC9.3 and    |
| ASZ7.3 | Potentiometer 1000 Ω       | SKB82..      | 1 x ASZ7.3        |
| ASZ6.6 | Stem heater AC 24 V        | SKB..        | 1 x ASZ6.6        |
| ASK51  | Mechanical stroke inverter |              | 1 x ASK51         |

## Ordering

When ordering please specify the quantity, product name and type code.

*Example:* **1 actuator, type SKB32.50** and  
**1 potentiometer, type ASZ7.3** and  
**1 Dual auxiliary switches ASC9.3**

## Delivery

The actuator, valve and accessories are supplied in separate packaging and not assembled prior to delivery.

## Spare parts

See overview, section «Replacement parts», page 21.

| Valve type   | DN      | PN-class | $k_{vs}$ [m <sup>3</sup> /h] | data sheet |
|--|---------|----------|------------------------------|------------|
| <b>Two-port valves VV... (control valves or safety shut-off valves):</b>         |         |          |                              |            |
| VVF21.. <sup>1)</sup> Flange   | 25...80 | 6        | 1.9...100                    | 4310       |
| VVF22.. Flange   | 25...80 | 6        | 2.5...100                    | 4401       |
| VVF31.. <sup>1)</sup> Flange   | 15...80 | 10       | 2.5...100                    | 4320       |
| VVF32.. Flange   | 15...80 | 10       | 1.6...100                    | 4402       |
| VVF40.. <sup>1)</sup> Flange   | 15...80 | 16       | 1.9...100                    | 4330       |
| VVF42.. Flange   | 15...80 | 16       | 1.6...100                    | 4403       |
| VVF41.. <sup>1)</sup> Flange   | 50      | 16       | 19...31                      | 4340       |
| VVF45.. Flange   | 50      | 16       | 19...31                      | 4345       |
| VVF53.. Flange   | 15...50 | 25       | 0.16...40                    | 4405       |
| VVF52.. <sup>1)</sup> Flange   | 15...40 | 25       | 0.16...25                    | 4373       |
| VVF61.. Flange   | 15...50 | 40       | 0.19...31                    | 4382       |
| VVG41.. Threaded   | 15...50 | 16       | 0.63...40                    | 4363       |
| <b>Three-port valves VX... (control valves for «mixing» and «distribution»):</b> |         |          |                              |            |
| VXF21.. <sup>1)</sup> Flange   | 25...80 | 6        | 1.9...100                    | 4410       |
| VXF22.. Flange   | 25...80 | 6        | 2.5...100                    | 4401       |
| VXF31.. <sup>1)</sup> Flange   | 15...80 | 10       | 2.5...100                    | 4420       |
| VXF32.. Flange   | 15...80 | 10       | 1.6...100                    | 4402       |
| VXF40.. <sup>1)</sup> Flange   | 15...80 | 16       | 1.9...100                    | 4430       |
| VXF42.. Flange   | 15...80 | 16       | 1.6...100                    | 4403       |
| VXF41.. <sup>1)</sup> Flange   | 15...50 | 16       | 1.9...31                     | 4440       |
| VXF53.. Flange   | 15...50 | 25       | 1.6...40                     | 4405       |
| VXF61.. Flange   | 15...50 | 40       | 1.9...31                     | 4482       |
| VXG41.. Threaded   | 15...50 | 16       | 1.6...40                     | 4463       |

For admissible differential pressures  $\Delta p_{max}$  and closing pressures  $\Delta p_s$ , refer to the relevant valve data sheets.

<sup>1)</sup> Valves are phased-out

**Note** Third-party valves with strokes between 6...20 mm can be motorized, provided they are «closed with the de-energized» fail-safe mechanism and provided that the necessary mechanical coupling is available. For SKB32.. and SKB82.. the Y1 signal must be routed via an additional freely-adjustable end switch (ASC9.3) to limit the stroke.  
We recommend that you contact your local Siemens office for the necessary information.

**Rev. no.** Overview table, see page 21.

**Technology**

**Principle of electro-hydraulic actuators**

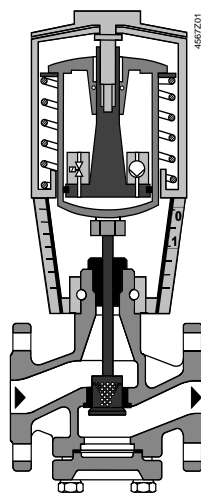

Valve closed

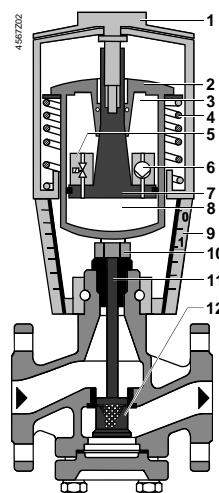

Valve open

- 1 Manual adjuster
- 2 Pressure cylinder
- 3 Suction chamber
- 4 Return spring
- 5 Solenoid valve
- 6 Hydraulic pump
- 7 Piston
- 8 Pressure chamber
- 9 Position indicator (0 to 1)
- 10 Coupling
- 11 Valve stem
- 12 Plug

|  |  |
|--|--|
| Opening the valve  | The hydraulic pump (6) forces oil from the suction chamber (3) to the pressure chamber (8) and thereby moving the pressure cylinder (2) downwards. The valve stem (11) retracts and the valve opens. Simultaneously the return spring (4) is compressed.   |
| Closing the valve  | Activating the solenoid valve (5) allows the oil in the pressure chamber to flow back into the suction chamber. The compressed return spring moves the pressure cylinder upwards. The valve stem extends and the valve closes.   |
| Manual operation mode  | For manual operation, swing out the crank so that the display window becomes visible. By rotating the crank or the manual adjustment knob, the display window shows the engagement bar and/or the scale dial with stroke indication.<br><br>Turning the manual adjuster (1) clockwise moves the pressure cylinder downwards and opens the valve. Simultaneously the return spring is compressed.<br>In the manual operation mode the control signals Y and Z can further open the valve but cannot move to the «0%» stroke position of the valve. To retain the manually set position, switch off the power supply or disconnect the control signals Y and Z. In the display window the red indicator dial is visible. |
| Note: Controller in manual operation   | When setting the controller for a longer time period to manual operation, we recommend adjusting the actuator with the manual adjuster to the desired position. This guarantees that the actuator remains in this position for that time period. Attention: Do not forget to switch back to automatic operation after the controller is set back to automatic control.   |
| Automatic mode   | Turn the manual adjuster counterclockwise to the end stop. The pressure cylinder moves upward to the «0%» stroke position of the valve. In the display window the red scale disappears and the crank can be swing closed.  |
| Minimal volumetric flow  | The actuator can manually be adjusted to a stroke position > 0 % allowing its use in applications requiring constantly a minimal volumetric flow.  |
| <b>Spring-return facility</b>  | The SKB32.51, SKB82.51.. and SKB62.. actuators, which feature a spring-return function, incorporate a solenoid valve which opens if the control signal or power fails. The return spring causes the actuator to move to the «0 %» stroke position and closes the valve.  |
| <b>SKB32../SKB82..</b><br>3-position control signal  | The actuator is controlled by a 3-position signal either via terminals Y1 or Y2 and generates the desired stroke by means of above described principle of operation. <ul style="list-style-type: none"> <li>• Voltage on Y1                      piston extends                      valve opens</li> <li>• Voltage on Y2                      piston retracts                      valve closes</li> <li>• No voltage on Y1 and Y2      piston / valve stem remain in the respective position</li> </ul>  |
| <b>SKB62.., SKB60</b><br>Y control signal<br>DC 0...10 V and/or<br>DC 4...20 mA,<br>0...1000 Ω | The valve is either controlled via terminal Y or override control Z. The positioning signal Y generates the desired stroke by means of above described principle of operation. <ul style="list-style-type: none"> <li>• Signal Y increasing:              piston extends                      valve opens</li> <li>• Signal Y decreasing:              piston retracts                      valve closes</li> <li>• Signal Y constant:                piston / valve stem remain in the respective position</li> <li>• Override control Z                see description of override control input, page 8</li> </ul>  |
| Frost protection monitor<br>Frost protection<br>thermostat                                     | A frost protection thermostat can be connected to the SKB6.. actuator. The added signals from the QAF21.. and QAF61.. require the use of SKB62UA actuators. Notes on special programming of the electronics are described under «Enhanced electronics» on page 5 «Connection diagrams» for operation with frost protection thermostat or frost protection monitor refer to page 17.  |

**Standard electronics**  
SKB62..., SKB60

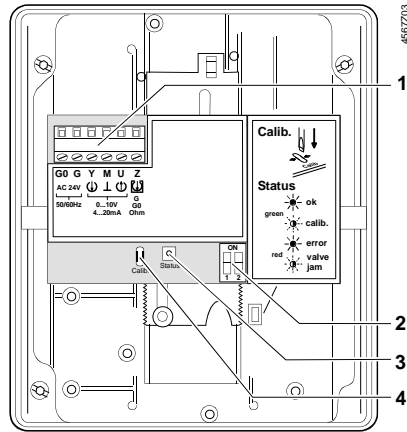

- 1 Connection terminals
- 2 Mode DIL switches
- 3 LED status indication
- 4 Slot for calibration

**DIL switches**  
SKB62..., SKB60

|               | Positioning signal Y<br>Position feedback U | Flow characteristic               |
|---------------|---|-----------------------------------|
| <b>ON</b>     | 4567Z05<br>DC 4...20 mA                     | 4567Z07<br>lin = linear           |
| <b>OFF *)</b> | 4567Z06<br>DC 0...10 V                      | 4567Z08<br>log = equal percentage |

\*) Factory setting:  
All switches OFF

Relationship between control signal Y and volumetric flow

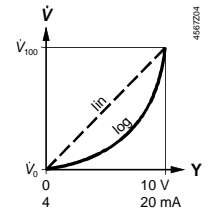

**Enhanced electronics**  
SKB62UA

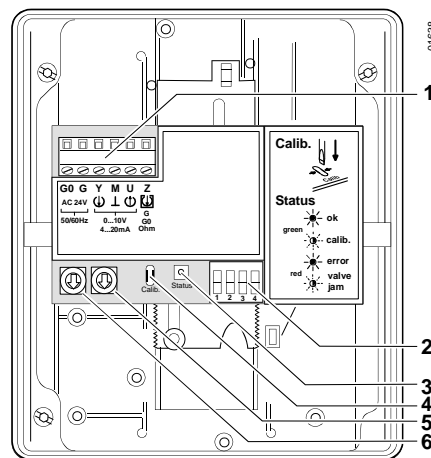

- 1 Connection terminals
- 2 DIL switches
- 3 LED status indication
- 4 Stroke calibration
- 5 Rotary switch **Up** (factory setting 0)
- 6 Rotary switch **Lo**

**DIL switches**  
SKB62UA

|              | Direction of operation | Sequence control or stroke limit control               | Control signal Y<br>Position feedback U | Flow characteristic    |
|--------------|------------------------|--|---|------------------------|
| <b>ON</b>    | reverse-acting         | Sequence control<br>Signal addition<br>QAF21../QAF61.. | DC 4... 20 mA                           | lin = linear           |
| <b>OFF *</b> | direct-acting          | Stroke limit control                                   | DC 0...10 V                             | log = equal percentage |

\* Factory settings: all switches OFF

Relationship between control signal Y and volumetric flow

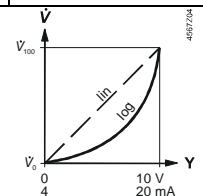

Selection of direction of operation  
SKB62UA

- With normally-closed valves, «direct-acting» means that with a signal input of 0 V, the valve closes (applies to all Siemens valves listed under «Equipment combinations» on page 3)
- With normally-open valves, «direct-acting» means that with a signal input of 0 V, the valve is open.

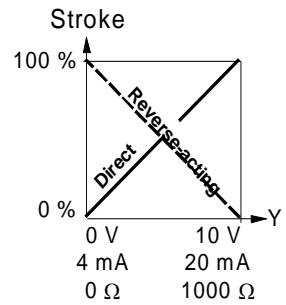
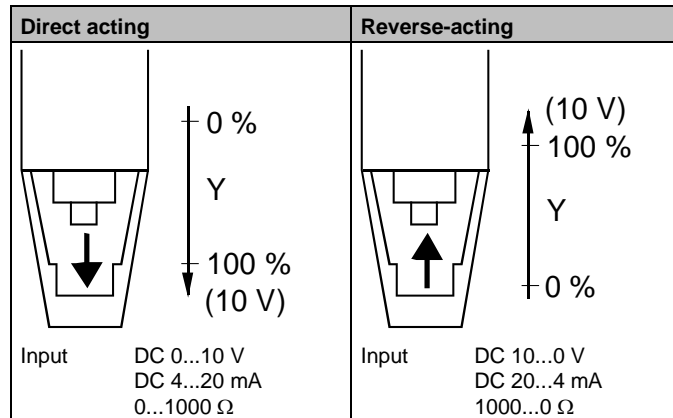

Note

The mechanical spring-return function is not affected by the direction of operation selected.

Stroke limit control and sequence control  
SKB62UA

**Setting the stroke limit control**

The rotary switches LO and UP can be used to apply an upper and lower limit to the stroke in increments of 3%, up to a maximum of 45%.

| Position of LO | Lower stroke limit | Position of UP | Upper stroke limit |
|----------------|--------------------|----------------|--------------------|
| 0              | 0%                 | 0              | 100%               |
| 1              | 3%                 | 1              | 97%                |
| 2              | 6%                 | 2              | 94%                |
| 3              | 9%                 | 3              | 91%                |
| 4              | 12%                | 4              | 88%                |
| 5              | 15%                | 5              | 85%                |
| 6              | 18%                | 6              | 82%                |
| 7              | 21%                | 7              | 79%                |
| 8              | 24%                | 8              | 76%                |
| 9              | 27%                | 9              | 73%                |
| A              | 30%                | A              | 70%                |
| B              | 33%                | B              | 67%                |
| C              | 36%                | C              | 64%                |
| D              | 39%                | D              | 61%                |
| E              | 42%                | E              | 58%                |
| F              | 45%                | F              | 55%                |

**Setting the sequence control**

The rotary switches LO and UP can be used to determine the starting point or the operating range of a sequence.

| Position of LO | Starting point for sequence control | Position of UP | Operating range of sequence control |
|----------------|-------------------------------------|----------------|-------------------------------------|
| 0              | 0 V                                 | 0              | 10 V                                |
| 1              | 1 V                                 | 1              | 10 V *                              |
| 2              | 2 V                                 | 2              | 10 V **                             |
| 3              | 3 V                                 | 3              | 3 V ***                             |
| 4              | 4 V                                 | 4              | 4 V                                 |
| 5              | 5 V                                 | 5              | 5 V                                 |
| 6              | 6 V                                 | 6              | 6 V                                 |
| 7              | 7 V                                 | 7              | 7 V                                 |
| 8              | 8 V                                 | 8              | 8 V                                 |
| 9              | 9 V                                 | 9              | 9 V                                 |
| A              | 10 V                                | A              | 10 V                                |
| B              | 11 V                                | B              | 11 V                                |
| C              | 12 V                                | C              | 12 V                                |
| D              | 13 V                                | D              | 13 V                                |
| E              | 14 V                                | E              | 14 V                                |
| F              | 15 V                                | F              | 15 V                                |

\* Operating range of QAF21.. (see below)  
 \*\* Operating range of QAF61.. (see below)  
 \*\*\* The smallest adjustment is 3 V; control with 0...30 V is only possible via Y.

Stroke control with QAF21.. / QAF61.. signal addition  
SKB62UA only

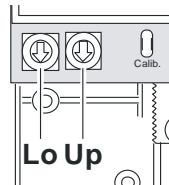

**Setting the signal addition**

The operating range of the frost protection monitor (QAF21.. or QAF61..) can be defined with rotary switches LO and UP.

| Position of LO | Sequence control start point | Position of UP | QAF21.. / QAF61.. operating range |
|----------------|------------------------------|----------------|-----------------------------------|
| 0              |                              | 1              | QAF21..                           |
| 0              |                              | 2              | QAF61..                           |

**Calibration**  
SKB62.., SKB60

In order to determine the stroke positions 0 % and 100 % in the valve, calibration is required on initial commissioning:

**Prerequisites**

- Mechanical coupling of the actuator SKB6.. with a Siemens valve
- **Actuator must be in «Automatic operation» enabling stroke calibration to capture the effective 0 % and 100 % values**
- AC 24 V power supply
- Housing cover removed

**Calibration**

1. Short-circuit contacts in calibration slot (e.g. with a screwdriver)
2. Actuator moves to «0 %» stroke position (1) (valve closed)
3. Actuator moves to «100 %» stroke position (2) (valve open)
4. Measured values are stored

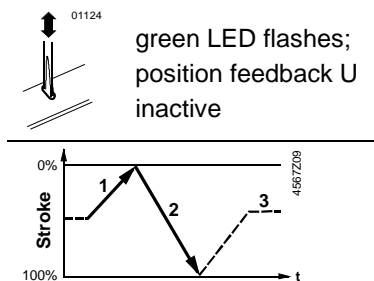





**Normal operation**

- |  |   |
|--|---|
| 5. Actuator moves to the position (3) as indicated by signals Y or Z | green LED is lit permanently; position feedback U active, the values correspond to the actual positions |
|--|---|

A lit red LED indicates a calibration error.  
 The calibration can be repeated any number of times.

**Indication of operating state**  
SKB62..., SKB60

The LED status indication indicates operational status with dual-colored LED and is visible with removed cover.

| LED   | Indication   | Function                                    | Remarks, troubleshooting   |
|-------|--|---|--|
| Green | Lit       | Normal operation                            | Automatic operation; everything o.k.   |
|       | Flashing  | Calibration in progress                     | Wait until calibration is finished (LED stops flashing, green or red LED will be lit)                      |
| Red   | Lit       | Faulty stroke calibration<br>Internal error | Check mounting<br>Restart stroke calibration (by short-circuiting calibration slot)<br>Replace electronics |
|       | Flashing  | Inner valve jammed                          | Check valve  |
| Both  | Dark      | No power supply<br>Electronics faulty       | Check mains network, check wiring<br>Replace electronics   |

As a general rule, the LED can assume only the states shown above (continuously red or green, flashing red or green, or off).

**Override control input Z**  
SKB62..., SKB60

Override control input can be operated in following different modes of operation

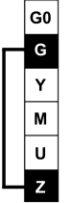
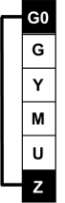
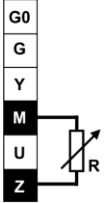
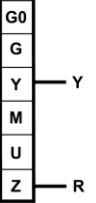
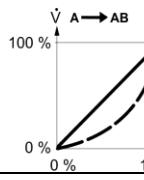
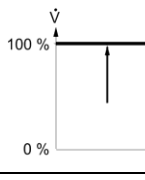
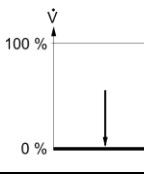
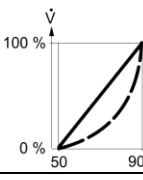
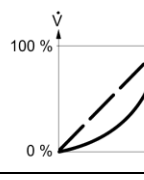
|             |          | Z-mode  |  |   |   |   |
|-------------|----------|---|--|---|---|---|
|             |          | no function   | fully open   | closed  | override with 0...1000 Ω  | Signal addition SKB62UA only  |
| Connections |          |                               |                                  |                                   |   |   |
|             | Transfer |                              |                                 |                                  |    |    |
|             |          | linear or equal-percentage  |  |   | linear or equal-percentage  | linear or equal-percentage  |
|             |          | <ul style="list-style-type: none"> <li>Z-contact not connected</li> <li>Valve stroke follows Y-input</li> </ul> | <ul style="list-style-type: none"> <li>Z-contact connected directly to G</li> <li>Y-input has no effect</li> </ul> | <ul style="list-style-type: none"> <li>Z-contact connected directly to G0</li> <li>Y-input has no effect</li> </ul> | <ul style="list-style-type: none"> <li>Z-contact connected to M via resistor R</li> <li>Starting position at 50 Ω / end position at 900 Ω</li> <li>Y-input has no effect</li> </ul> | <ul style="list-style-type: none"> <li>Z-contact is connected to R of the frost protection monitor QAF21... or QAF61...</li> <li>Valve stroke follows signals Y and R(Z)</li> </ul> |

Note Shown operation modes are based on the factory setting «direct acting»  
Y-input has no effect in Z-mode.



SKB..

**ASZ6.6 (S55845-Z108)**

stem heater

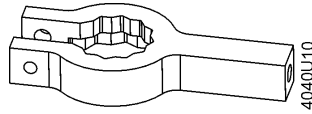

- for media below 0 °C
- mount between valve and actuator

SKB32.., SKB82..

**ASC9.3**  
double auxiliary switch

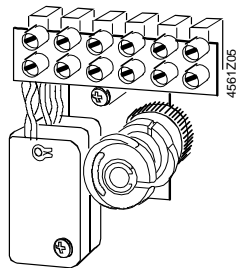

adjustable switching points

**ASZ7.3**  
potentiometer

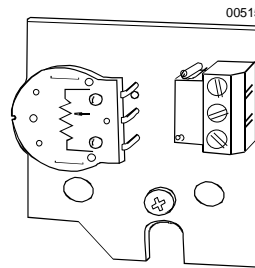

0...1000 Ω

**ASK51**  
stroke inverter

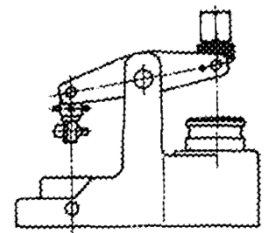

0 % actuator stroke corresponds to 100 % valve stroke; mount between valve and actuator

Note: ASZ7.3

For the combination SIMATIC S5/S7 and position feedback message, we recommend actuators with DC 0...9.8 V feedback signals.

The signal peaks that occur in the potentiometer ASZ7.3 may result in error messages on Siemens SIMATIC.

This is not the case when combined with Siemens HVAC controllers.

The reason is that SIMATIC has a higher resolution and faster response time.

SKB62.., SKB60

**ASC1.6**  
auxiliary switch

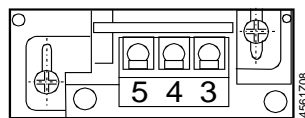

switching point 0...5 % stroke

See section «Technical data» on page 14 for more information.

Conduct the electrical connections in accordance with local regulations on electrical installations as well as the internal or connection diagrams.

Caution 

**Safety regulations and restrictions designed to ensure the safety of people and property must be observed at all times!**



**The plant operator must also ensure compliance with applicable guidelines on cable insulation when using a safety limiter. Failure to comply may cause the safety limiter function to fail.**

Caution 

**For media below 0 °C the ASZ6.6 stem heater is required to keep the valve from freezing. For safety reasons the stem heater is designed for an operating voltage of AC 24 V / 30 W.**

**For this case, do not insulate the actuator bracket and the valve stem, as air circulation must be ensured. Do not touch the hot parts without prior protective measures to avoid burns.**

**Non-observance of the above may result in accidents and fires!**

**Recommendation: Above 140 °C insulating the valves is strictly recommended.**

Observe admissible temperatures, refer to «Use» on page 2 and «Technical data» on page 14

If an auxiliary switch is required, its switching point should be indicated on the plant schematic.

Every actuator must be driven by a dedicated controller, refer to «Connection diagrams», page 17.

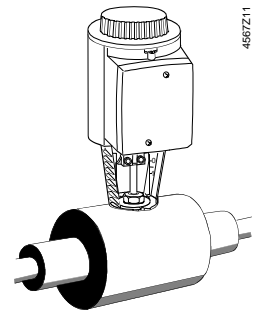

## Mounting instructions

Mounting Instruction 74 319 0324 0 for fitting the actuator to the valve are by packed in the actuator packaging. The instructions for accessories are enclosed with the accessories themselves.

| Accessories | Installation instructions | Accessory        | Mounting instructions |
|-------------|---------------------------|------------------|-----------------------|
| ASC1.6      | G4563.3                   | ASK51            | M4561.6               |
| ASC9.3      | G4561.3                   | ASZ7.3           |                       |
| SKB..       | M3240                     | ACT control unit | M4568                 |
| SKB..       |                           | QAF21..          |                       |
|             |                           | ASZ6.6           | M4501.1               |

Orientation

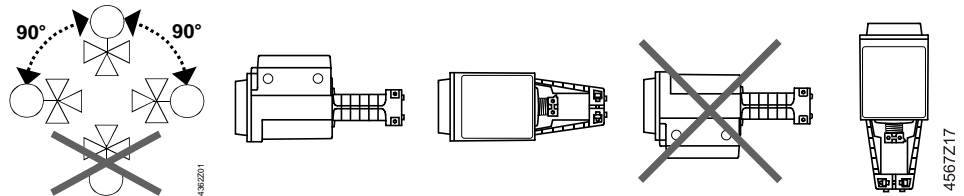

## Commissioning notes

When commissioning the system, check the wiring and functions, and set any auxiliary switches and potentiometers as necessary, or check the existing settings.

Cylinder with valve stem connector fully retracted  
→ stroke = 0%

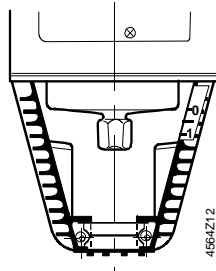

Cylinder with valve stem connector fully extended  
→ stroke = 100%

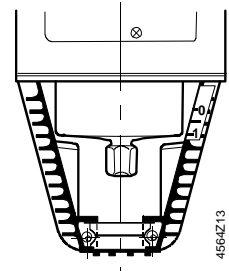

**The manual adjuster must be rotated counterclockwise to the end stop. This causes the Siemens valves, types VVF.. and VXF.. to close (stroke = 0 %).**

## Automatic operation

For automatic operation, the crank (2) on the manual adjustment knob (1) must be engaged. If not engaged, turn the crank counter-clockwise until the display window (3) neither shows the scale (4) nor the crank engagement bar.

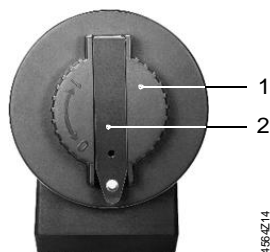

Engaged crank (2) on the manual adjustment knob (1)

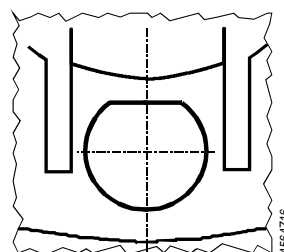

Display window with invisible scale dial and crank engagement bar

## Manual operation

For manual operation, swing out the crank (2) so that the display window (3) becomes visible. By rotating the crank or the manual adjustment knob (1), the display window shows the engagement bar and/or the scale dial with stroke indication.

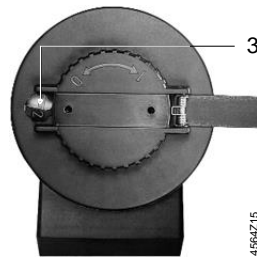

Swung-out crank,  
display window (3)

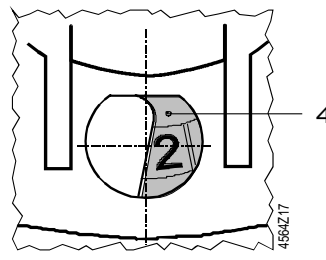

Display window with scale dial (4) and stroke  
indication

## Maintenance notes

The SKB.. actuators are maintenance-free.



### When servicing the actuator:

- **Switch off pump of the hydronic loop**
- **Interrupt the power supply to the actuator**
- **Close the main shutoff valves in the system**
- **Release pressure in the pipes and allow them to cool down completely**
- **If necessary, disconnect electrical connections from the terminals**
- **The actuator must be correctly fitted to the valve before recommissioning.**

Recommendation SKB6...: trigger stroke calibration.

Repair

«Replacement parts», see page 21.



### A damaged housing or cover represents an injury risk

- **NEVER** uninstall an actuator from the valve
- **Uninstall the valve-actuator combination (actuating device) as a complete device**
- **Use only properly trained technicians to uninstall the unit**
- **Send the actuating device together with an error report to your local Siemens representative for analysis and disposal**
- **Properly mount the new actuating device (valve and actuator)**

Parts could fly ultimately resulting in injuries from uninstalling an actuator with a damaged valve housing due to the tensioned return spring.

## Disposal

---



### **WARNING**

#### **Tensioned return spring**

Opening the actuator housing can release the tensioned return spring resulting in flying parts that may cause injury.

- Do not open the actuator body.

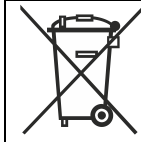

The device is considered electrical and electronic equipment for disposal in terms of the applicable European Directive and may not be disposed of as domestic garbage.

- Dispose of the device through channels provided for this purpose.
- Comply with all local and currently applicable laws and regulations.

## Warranty

---

Technical data on specific applications are valid only together with Siemens products listed under "Equipment combinations", page 3. Siemens rejects any and all warranties in the event that third-party products are used.

## Technical data

|                                       |   | SKB32..  | SKB82..  | SKB6..  |  |
|---------------------------------------|---|--|--|---|--|
| Power supply                          | Operating voltage   | AC 230 V   | AC 24 V  | AC 24 V   |  |
|                                       | Voltage tolerance   | ± 15 %   | ± 20 %   | ± 20 %  |  |
|                                       |   | SELV / PELV  |  |   |  |
|                                       | Frequency   | 50 or 60 Hz  |  |   |  |
|                                       | Max. Power consumption at 50 Hz   | SKB32.50:<br>10 VA / 8 W<br>SKB32.51:<br>16 VA / 12 W  | SKB82.50, ..50U<br>8 VA / 7 W<br>SKB82.51, ..51U<br>12 VA / 9 W                      | SKB60..<br>10 VA / 8 W<br>SKB62..<br>14 VA / 10 W   |  |
| External supply cable fuse            | min. 0.5 A, slow<br>max. 6 A, slow  | min. 1 A, slow<br>max. 10 A, slow  |  |   |  |
| Signal inputs                         | Control signal  | 3-position   |  | DC 0...10 V,<br>DC 4...20 mA<br>or<br>0...1000 Ω  |  |
|                                       | Terminal Y  | Voltage<br>Input impedance<br>Current<br>Input impedance<br>Signal resolution<br>Hysteresis  |  | DC 0...10 V<br>100 kΩ<br>DC 4...20 mA<br>240 Ω<br>< 1%<br>1 %                                 |  |
|                                       | Terminal Z<br>Override control  | Resistor<br>Z not connected, priority terminal Y<br>Z connected directly to G<br>Z connected directly to G0<br>Z connected to M via 0...1000 Ω |  | 0...1000 Ω<br>No function<br>max. stroke 100 %<br>min. stroke 0 %<br>stroke proportional to R |  |
|                                       | Terminal U  | voltage<br>load impedance<br>Current<br>load impedance   |  | DC 0...9.8 V<br>> 10 kΩ<br>DC 4...19.6 mA<br>< 500 Ω  |  |
| Position feedback                     | Cable cross-sectional area  | 0.5 ... 2.5 mm <sup>2</sup> / AWG 21 ... 14  |  |   |  |
|                                       | Positioning time at 50 Hz <sup>1)</sup>   |  |  |   |  |
| Connecting cable                      | opening   | SKB32.5.. 120 s  | SKB82.5.. 120 s  | 120 s   |  |
|                                       | Closing   | SKB32.5.. 120 s  | SKB82.5.. 120 s  | 10 s  |  |
|                                       | Spring-return time <sup>1)</sup>  | SKB32.51 10 s  | SKB82.51 10 s  | SKB62.. 10 s  |  |
|                                       | Positioning force   | 2800 N   |  |   |  |
|                                       | Nominal stroke  | 20 mm  |  |   |  |
|                                       | Max. permissible medium temperature   | -25...220 °C<br>< 0 °C: requires stem heater ASZ6.6  |  |   |  |
|                                       | <sup>1)</sup> At room temperature (23°C), low ambient temperatures or high Δp may prolong these times |  |  |   |  |
|                                       | Electrical connections  | Cable entry  | 4 x M20 (Ø 20,5 mm)<br>with knockouts for standard ½" conduit connectors (Ø 21.5 mm) |   |  |
|                                       | Standards, directives and approvals   | Product standard   | EN 60730-x   |   |  |
|                                       |   | Electromagnetic compatibility (Applications)   | For use in residential, commercial, light-industrial and industrial environments     |   |  |
| EU conformity (CE)                    |   | A5W00007751 <sup>1)</sup>  |  |   |  |
| RCM-conformity (EMC)<br>AC 230 V      |   | A5W00007895 <sup>1)</sup>  |  |   |  |
| EAC conformity                        |   | Eurasia conformity for all SKB..   |  |   |  |
| UL certification: UL, cUL<br>AC 230 V |   | -  |  |   |  |
| AC 24 V                               |   | UL 873, <a href="http://ul.com/database">http://ul.com/database</a>  |  |   |  |
| Environmental                         |   | The product environmental declarations CE1E4564en01 <sup>1)</sup> and  |  |   |  |

|  |                                 | SKB32..   | SKB82..                               | SKB6..                                |
|--|---------------------------------|---|---------------------------------------|---------------------------------------|
| compatibility  |                                 | CE1E4564en02 <sup>1)</sup> contain data on RoHS compliance, materials composition, packaging, environmental benefit and disposal. |                                       |                                       |
| Dimensions / Weight  | Dimensions                      | refer to «Dimensions», page 20  |                                       |                                       |
|  | Weight (excl. packaging)        | SKB32.50.. 9.15 kg  | SKB82.50 9.15 kg<br>SKB82.50U 9.45 kg | SKB60/62 9.20 kg<br>SKB62U/UA 9.50 kg |
| Materials  | ASK51 stroke inverter           | 1.10 kg   |                                       |                                       |
|  | Actuator housing, bracket       | Die-cast aluminum   |                                       |                                       |
|  | Housing box and manual adjuster | Plastic   |                                       |                                       |
| <sup>1)</sup> The documents can be downloaded from <a href="http://siemens.com/bt/download">http://siemens.com/bt/download</a> . |                                 |   |                                       |                                       |

| Accessories                          |   | SKB32..., SKB82..                           | SKB6..  |
|--------------------------------------|---|---|---|
| ASC1.6<br>Auxiliary switch           | Switching capacity  |   | AC 24 V,<br>10 mA...4 A resistive,<br>2 A inductive |
| ASC9.3<br>double<br>auxiliary switch | Switching capacity per<br>auxiliary switch                            | AC 250 V, 6 A resistive, 2.5 A inductive    |   |
| ASZ7.3<br>Potentiometer              | Change in overall resistance<br>of potentiometer at nominal<br>stroke | 0...1000 Ω                                  |   |
| ASZ6.6<br>stem heater                | Operating voltage   | AC 24 V ± 20 %                              |   |
|                                      | Power consumption   | 40 VA / 30 W                                |   |
|                                      | Inrush current  | Max. 8,5 A (max. temperature 85 °C / 185 F) |   |

### SKB62UA enhanced functions

|                        |  |  |
|------------------------|--|--|
| Direction of operation | Direct-acting, reverse-acting                | DC 0...10 V / DC 10...0 V                    |
|                        |  | DC 4...20 mA / DC 20...4 mA                  |
| Stroke limit control   | Range of lower limit<br>Range of upper limit | 0...1000 Ω / 1000...0 Ω                      |
|                        |  | 0...45 % adjustable<br>100...55 % adjustable |
| Sequence control       | Terminal Y                                   | Starting point of sequence                   |
|                        |  | 0...15 V adjustable                          |
|                        |  | Operating range of sequence                  |
| Signal addition        | Z connected to R of                          | Frost protection monitor QAF21..             |
|                        |  | 0...1000 Ω, added to Y signal                |
|                        |  | Frost protection monitor QAF61..             |
|                        |  | DC 1.6 V, added to Y signal                  |

## Ambient conditions and protection data

|   |  |
|---|--|
| Classification to IEC/EN 60730                              | Automatic action: Type 1AA / Type 1AC / Modulation Action                    |
|   | Pollution degree: 2  |
| Housing protection as per IEC/EN 60529                      | IP54   |
| Environmental conditions                                    |  |
| Transportation (in transport packaging) to IEC/EN 60721-3-2 | Class 2K3<br>Temperature -30...65 °C<br>Humidity 5...95 % (no condensation)  |
| Operation to IEC/EN 60721-3-3                               | Class 3K5<br>Temperature -15...<55 °C<br>Humidity 5...95 % (no condensation) |
| Storage to IEC/EN 60721-3-1                                 | Class 1K3<br>Temperature -15...55 °C<br>Humidity 5...95 % (no condensation)  |

## Internal diagrams

### SKB32.51

AC 230 V, 3-Position

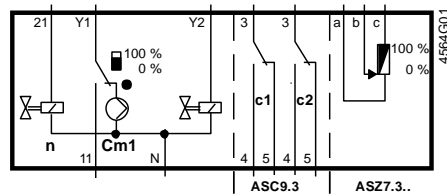

- Cm1** end switch
- n** solenoid valve for spring-return
- c1, c2** ASC9.3 double auxiliary switch
- a, b, c** ASZ7.3 potentiometer
- Y1** Positioning signal «open»
- Y2** Positioning signal «close»
- 21** spring-return function
- N** neutral conductor

### SKB32.50

AC 230 V, 3-Position

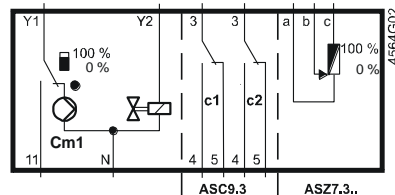

- Cm1** end switch
- n** solenoid valve for spring-return
- c1, c2** ASC9.3 double auxiliary switch
- a, b, c** ASZ7.3 potentiometer
- Y1** Positioning signal «open»
- Y2** Positioning signal «close»
- 21** spring-return function
- G** System potential

### SKB82.51

AC 24 V, 3-Position

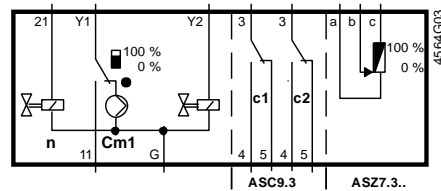

- Cm1** end switch
- n** solenoid valve for spring-return
- c1, c2** ASC9.3 double auxiliary switch
- a, b, c** ASZ7.3 potentiometer
- Y1** Positioning signal «open»
- Y2** Positioning signal «close»
- 21** spring-return function
- G** System potential

### SKB82.50

AC 24 V, 3-Position

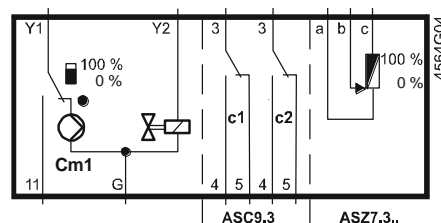

### SKB60, SKB62

SKB62U

SKB62UA

AC 24 V, DC 0...10 V,  
4...20 mA, 0...1000 Ω

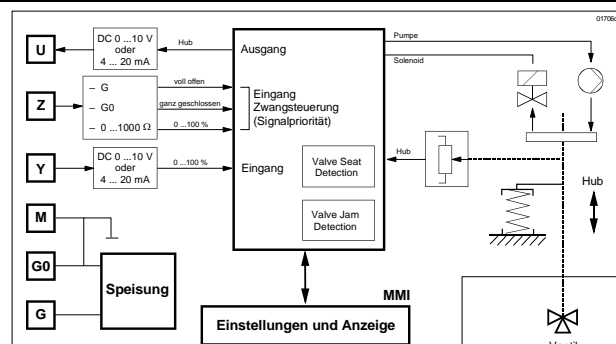

- U** position indication
- Z** override control
- Y** positioning signal
- M** measuring neutral
- G0** operating voltage AC 24 V: system neutral (SN)
- G** operating voltage AC 24 V: system potential (SP)  
Switching without power as a spring return function



## Connection terminals

### SKB6..

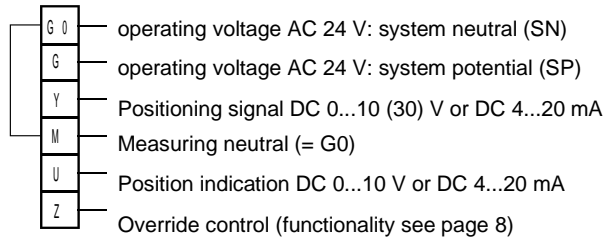

### Auxiliary switch ASC1.6

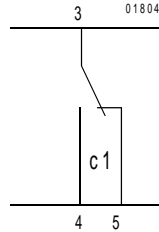

## Connection diagrams

### SKB32.. AC 230 V 3-Position

#### SKB32.51

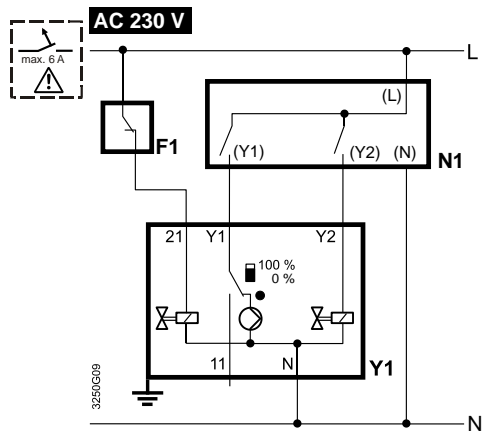

**F1** safety limiter (eg temperature limiter)  
**N1, N2** controller  
**Y1, Y2** actuators

**L** Phase  
**N** neutral

#### SKB32.50

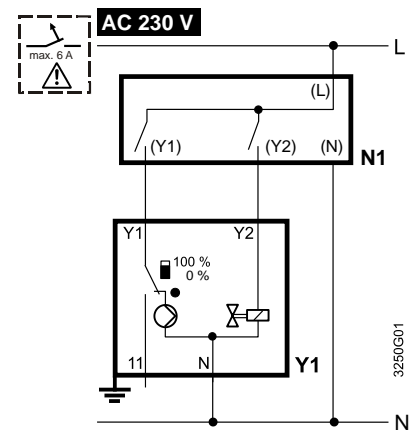

**Y1** Positioning signal «open»  
**Y2** Positioning signal «close»  
**21** Spring-return function

**SKB82..**  
AC 24 V  
3-Position

**SKB82.51, SKB82.51U**

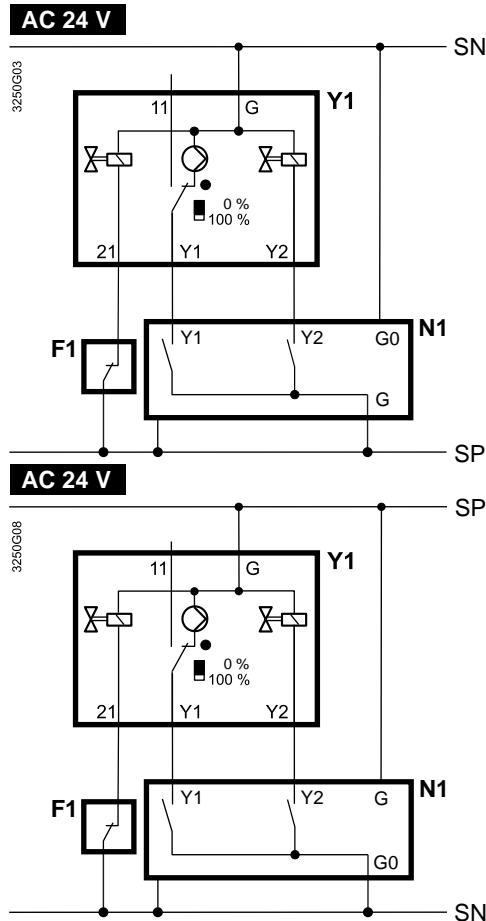

**SKB82.50, SKB82.50U**

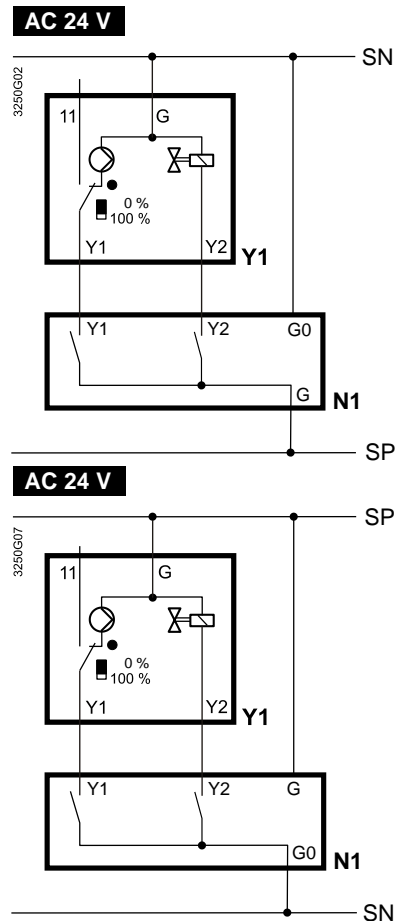

- |               |   |           |                         |           |                            |
|---------------|---|-----------|-------------------------|-----------|----------------------------|
| <b>F1</b>     | safety limiter (eg temperature limiter) | <b>SP</b> | Systempotential AC 24 V | <b>Y1</b> | Positioning signal «open»  |
| <b>N1, N2</b> | controller                              | <b>SN</b> | System neutral          | <b>Y2</b> | Positioning signal «close» |
| <b>Y1, Y2</b> | actuators                               |           |                         | <b>Z1</b> | Spring-return function     |

**SKB6..**  
AC 24 V  
DC 0...10 V, 4...20 mA,  
0...1000 Ω

**SKB60**

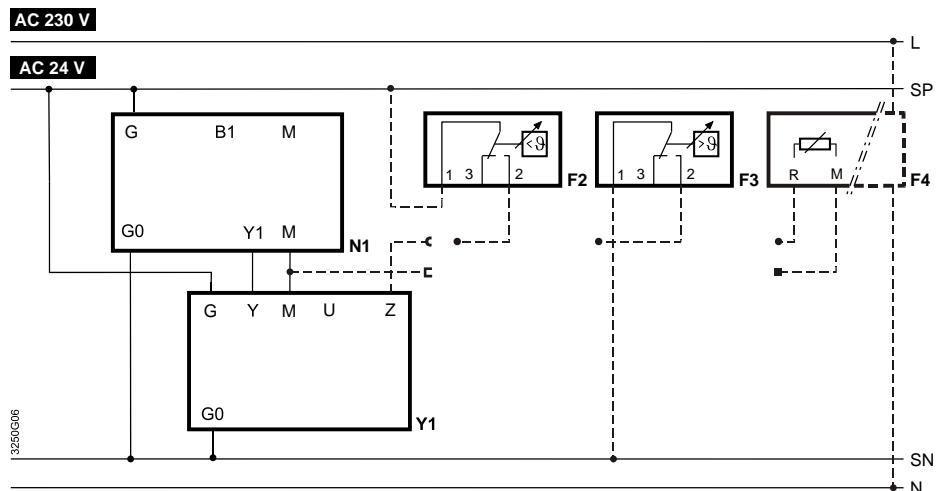

SKB62  
SKB62U  
SKB62UA

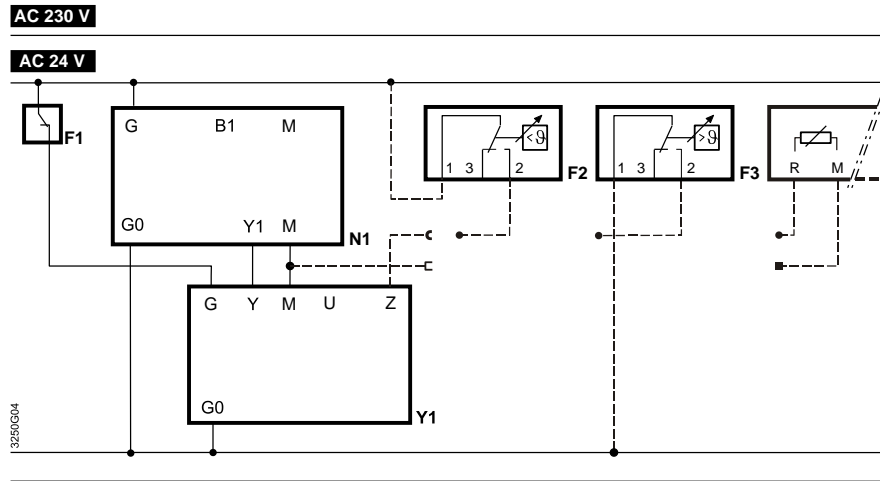

- Y1** actuator
- N1** controller
- F1** safety limiter (eg temperature limiter)
- F2** frost protection thermostat
  - terminals: 1 – 2 frost hazard / sensor is interrupted (thermostat closes with frost)
  - 1 – 3 normal operation
- F3** temperature detector
- F4** Frost protection monitor with 0...1000 Ω signal output, e.g. QAF21.. or QAF61.. (only SKB62UA)
- \*
- G (SP)** System potential AC 24 V
- G0 (SN)** System neutral
- \* Only with sequence control and the appropriate selector switch settings (see page 5ff)

**Danger**

When using the safety limiter F1, ensure that no mistakes may occur on cable insulation that may cancel out the temperature limiter function (applies to both 230 V as well as 24 V types).  
For SN earthing (e.g. PELV) comply under all circumstances with the note above.

## Dimensions

All dimensions in mm

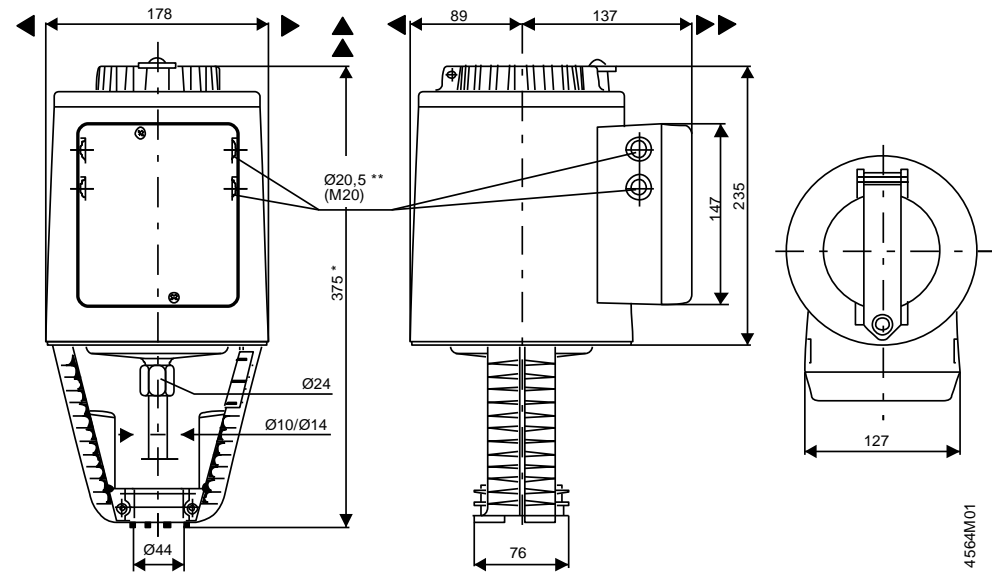

4564M01

- \* Height of actuator from plate with stroke inverter **ASK51** = 432 mm
- \*\* **SKB..U**: with knockouts for standard 1/2" conduit connectors (Ø 21.5 mm)
- ▶ = > 100 mm | Minimum clearance from ceiling or wall for mounting,
- ▶▶ = > 200 mm | connection, operation, maintenance etc.



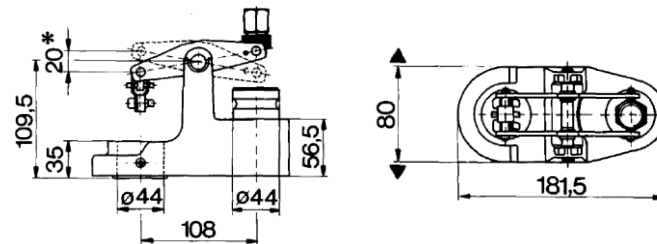

### ASK51 stroke inverter



\* Maximum stroke = 20 mm

## Replacement parts

Order numbers for replacement parts

|                      | Cover   | Hand control <sup>1)</sup>  | Clamp  | Stem connection   | Control unit  |
|----------------------|---|---|--|---|---|
| <b>Actuator type</b> |  |  |  |  |  |
| <b>SKB32.50</b>      | 410455828   | 426855108   | 410355768  | 417856498   |   |
| <b>SKB32.51</b>      | 410455828   | 426855108   | 410355768  | 417856498   |   |
| <b>SKB82.50</b>      | 410455828   | 426855108   | 410355768  | 417856498   |   |
| <b>SKB82.50U</b>     | 410455828   | 426855108   | 410356058  | 417856498   |   |
| <b>SKB82.51</b>      | 410455828   | 426855108   | 410355768  | 417856498   |   |
| <b>SKB82.51U</b>     | 410455828   | 426855108   | 410356058  | 417856498   |   |
| <b>SKB62</b>         | 410455828   | 426855108   | 410355768  | 417856498   | 466857488   |
| <b>SKB62U</b>        | 410455828   | 426855108   | 410356058  | 417856498   | 466857488   |
| <b>SKB60</b>         | 410455828   | 426855108   | 410355768  | 417856498   | 466857598   |
| <b>SKB62UA</b>       | 410455828   | 426855108   | 410356058  | 417856498   | 466857518   |

1) hand control, blue with mechanical parts

## Revision numbers

| Type reference | Valid from Rev.-No. | Type reference | Valid from Rev.-No. |
|----------------|---------------------|----------------|---------------------|
| SKB32.50       | ..D                 | SKB82.51U      | ..D                 |
| SKB32.51       | ..D                 | SKB62          | ..G                 |
| SKB82.50       | ..D                 | SKB62U         | ..G                 |
| SKB82.50U      | ..D                 | SKB60          | ..G                 |
| SKB82.51       | ..D                 | SKB62UA        | ..G                 |

Issued by:  
Siemens Switzerland Ltd  
Smart Infrastructure  
Global Headquarters  
Theilerstrasse 1a  
CH-6300 Zug  
+41 58 724-2424  
[www.siemens.com/buildingtechnologies](http://www.siemens.com/buildingtechnologies)

© Siemens Switzerland Ltd 2002  
Delivery and technical specifications subject to change