



ACVATIX™

Electromotoric rotary actuators for butterfly or slipper valves

SAL..

with 90° rotary angle

-
- SAL31.. Operating voltage AC 230 V, 3-position control signal
 - SAL61.. Operating voltage AC/DC 24 V, control signal 0...10 V, 4...20 mA, 0...1000 Ω
 - SAL81.. Operating voltage AC/DC 24 V, 3-position control signal
 - SAL61.. Position feedback, override control
 - For direct mounting on butterfly or slipper valves; no adjustments required
 - Manual adjuster, position indicator and status indication with LED
 - Optional functions with auxiliary switches, potentiometer

Use

For the operation of Siemens butterfly and slipper valves, types VKF41.., VKF46.., and VBF21.. as control or shutoff valves in heating, ventilation and air conditioning systems.

Type summary

Product no.	Stock no.	Angular rotation	Torque	Operating voltage	Positioning signal	Positioning time	LED	Manual adjuster ¹⁾	Extra functions	
SAL31.00T10 ¹⁾	S55162-A108	90°	10 Nm	AC 230 V	3-position	120 s	-	Push and fix	-	
SAL31.00T20 ¹⁾	S55162-A110		20 Nm			30 s				
SAL31.00T40 ¹⁾	S55162-A111		40 Nm			30 s				
SAL31.03T10 ¹⁾	S55162-A109		10 Nm	AC/DC 24 V	DC 0...10 V DC 4...20 mA 0...1000 Ω	120 s	✓			
SAL61.00T10 ²⁾	S55162-A100		20 Nm			30 s				
SAL61.00T20 ²⁾	S55162-A102		40 Nm			30 s				
SAL61.00T40 ²⁾	S55162-A103		40 Nm			30 s				
SAL61.03T10 ²⁾	S55162-A101		10 Nm			120 s				-
SAL81.00T10 ²⁾	S55162-A104		20 Nm			30 s				
SAL81.00T20 ²⁾	S55162-A106		40 Nm	30 s						
SAL81.00T40 ²⁾	S55162-A107		40 Nm	3-position	120 s	-				
SAL81.03T10 ²⁾	S55162-A105		10 Nm		30 s					

¹⁾ Approbation: CE

²⁾ Approbation: CE, UL

³⁾ Not designed for continuous operation

Electrical accessories

Product no.	Auxiliary switch ASC10.51	Potentiometer ASZ7.5	Function module AZX61.1
Stock no.	S55845-Z103	S55845-Z106	S55845-Z107
Max. 2 in total			
SAL31..	Max. 2	Max. 1	-
SAL61..	Max. 2	-	Max. 1 AZX61.1
SAL81..		Max. 1	-

Note: ASZ7.5

For the combination SIMATIC S5/S7 and position feedback message, we recommend actuators with DC 0...9.8 V feedback signals.

The signal peaks that occur in the potentiometer ASZ7.5 may result in error messages on Siemens SIMATIC.

This is not the case when combined with Siemens HVAC controllers.

The reason is that SIMATIC has a higher resolution and faster response time.

Use a 3-wire connection as the voltage divider for the potentiometer.

Powering the potentiometer over the wiper may result in a shorter lifecycle.

Signal peaks occurring in this operating mode increase in frequency and severity throughout its lifecycle.

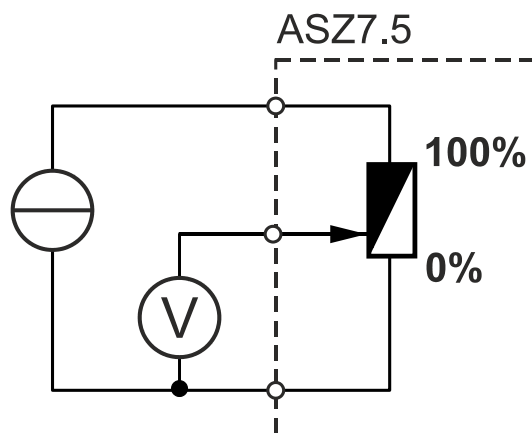

Mechanical accessories

Product no.	Weather shield ASK39.1	Mounting set				
		ASK31N for VBF21..	ASK32N		ASK33N for VKF41..	ASK35N for VKF45.. ²⁾
			VBF21..	VBI31.. ¹⁾ VCI31.. ¹⁾ VBG31.. ¹⁾		
Stock no.	S55845-Z109	S55845-Z100	S55845-Z211		S55845-Z101	S55845-Z102
SAL..T10	Max. 1	DN 65...150	DN 40...50	✓	✓	-
SAL..T20		-	-	-	-	DN 40...65
SAL..T40		-	-	-	-	DN 150...200

¹⁾ Types VBI31..., VCI31..., and VBG31.. are available only while stock lasts from 2019 on.

²⁾ Type VKF45.. was replaced by type VKF46.. in the year 2000.

Ordering



Example

Product no.	Stock no.	Description	Quantity
SAL31.00T10	S55162-A108	Rotary actuator	1
ASZ7.5	S55845-Z106	Potentiometer	1



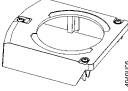
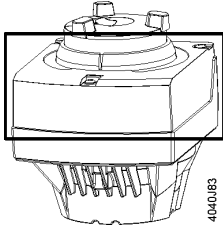

Delivery

Actuators, valves and accessories are supplied in individual packs.

Spare part kit

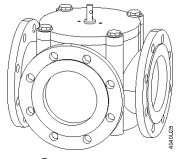
Stock number 8000060844	Housing cover 		
	2 adapters 		1 pc. 14 mm 1 pc. 11 mm
	4 screws 		2 pcs. M5 x 20 mm 2 pcs. M6 x 20 mm

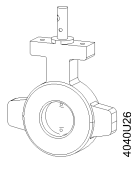
Combinations

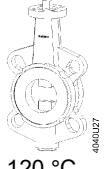
SAL..					Angular rotation Torque		SAL..T10	SAL..T20	SAL..T40
							10 Nm	90 ° 20 Nm	40 Nm
Slipper valves	Data Sheet	Valve type ¹⁾	DN	k_{vs} [m ³ /h]	Mounting set	Δp_{max} [kPa]			
PN6   1 °C... 120 °C	N4241	VBF21.40	40	25	ASK32N	30	-	-	
		VBF21.50	50	40					
		VBF21.65	65	63					
		VBF21.80	80	100	ASK31N				
		VBF21.100	100	160					
		VBF21.125	125	550					
		VBF21.150	150	820					
Butterfly valves						Δp_s [kPa]			
PN16   -10 °C...120 °C	N4131	VKF41.40	40	50	ASK33N	500	-	-	
		VKF41.50	50	80					
		VKF41.65	65	200					
		VKF41.80	80	400					
		VKF41.100	100	760					
		VKF41.125	125	1'000					
		VKF41.150	150	2'100					
		VKF41.200	200	4'000					
PN16   -10 °C...120 °C	N4136	VKF46.40	40	50	-	-	1600	-	
		VKF46.50	50	85					
		VKF46.65	65	215					
		VKF46.80	80	420					
		VKF46.100	100	800					
		VKF46.125	125	1010					

Product documentation

Detailed information about the New Generation actuators can be found in the basic documentation "Electromotoric actuators SAX..., SAL.." (CE1P4040en).

Notes

Engineering

SAL 31.. / SAL81..

3-position actuators must have their own specific controller, refer to "Connection Diagrams" (page 10).

SAL61..

Up to 10 actuators can drive in parallel on a controller output with a rating of 1 mA. Modulating actuators have an input impedance of 100 kΩ.

Mounting

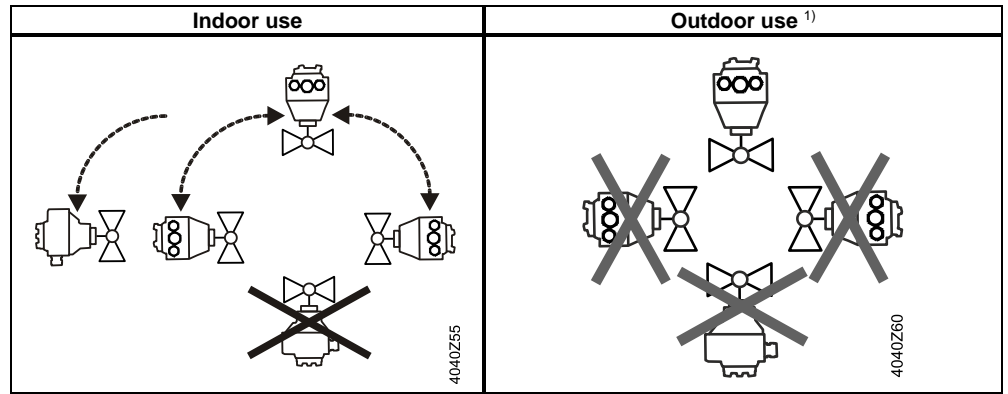

¹⁾ Only in connection with weather shield ASK39.1

Maintenance

The rotary actuators are maintenance-free.

Disposal



The device is considered electrical and electronic equipment for disposal in terms of the applicable European Directive and may not be disposed of as domestic garbage.

- Dispose of the device through channels provided for this purpose.
- Comply with all local and currently applicable laws and regulations.

Warranty

The engineering data specified in chapter "Combinations" (page 4) are only guaranteed in connection with the Siemens valves listed.

Note

When using the actuators in connection with slipper valves of other manufacture, correct functioning must be ensured by the user, and Siemens will assume no responsibility. The use of the rotary actuators SAL..T10 with butterfly valves is only permitted for the Siemens Series VKF41..

Technical Data

		SAL..
Power supply	Operating voltage SAL31.. SAL61.. SAL81..	AC 230 V ±15% AC 24 V ± 20% / DC 24 V + 20% / -15% (SELV) AC 24 V ±20% / DC 24 V + 20 % / -15% (SELV)
	Frequency	45...65 Hz
	External supply line protection (EU)	<ul style="list-style-type: none"> • Fuse slow 6...10 A • Circuit breaker max. 13 A, Characteristic B, C, D according to EN 60898 • Power source with current limitation of max. 10 A
	Power consumption at 50 Hz SAL31.00T10 Rotary actuator turns SAL31.00T20 Rotary actuator turns SAL31.00T40 Rotary actuator turns SAL31.03T10 Rotary actuator turns SAL61.00T10 Rotary actuator turns SAL61.00T20 Rotary actuator turns SAL61.00T40 Rotary actuator turns SAL61.03T10 Rotary actuator turns SAL81.00T10 Rotary actuator turns SAL81.00T20 Rotary actuator turns SAL81.00T40 Rotary actuator turns SAL81.03T10 Rotary actuator turns	3.5 VA / 2 W 4.5 VA / 2.75 W 7 VA / 4 W 5,5 VA / 3.25 W 5 VA / 2.5 W 6 VA / 2.75 W 9 VA / 4 W 7.5 VA / 3.5 W 3 VA / 2 W 4 VA / 2.75 W 6 VA / 3.75 W 5 VA / 3.5 W
Function data	Positioning times (with spec. nominal angular rotation) SAL31.00., SAL61.00., SAL81.00 SAL31.03T10, SAL61.03T10 SAL81.03T10 Torque SAL..T10 SAL..T20 SAL..T40 Rotary angle Permissible medium temperature (valve fitted)	120 s 30 s 10 Nm running / min. 4 Nm holding 20 Nm running / min. 14 Nm holding 40 Nm running / min. 14 Nm holding 90° -10...120 °C
Signal inputs	Positioning signal "Y" SAL31.., SAL81.. SAL31.. Voltage SAL81.. Voltage SAL61.. (DC 0...10 V) Current draw Input impedance SAL61.. (DC 4...20 mA) Current draw Input impedance	3-position AC 230 V ±15% AC 24 V ± 20 % / DC 24 V + 20 % / -15% ≤ 0.1 mA ≥100 kΩ DC 4...20 mA ± 1% ≤500 Ω
Parallel operation	SAL61..	≤ 10 (depending on controller output)
Forced control	Positioning signal "Z" SAL61.. R = 0...1000 Z connected to G Z connected to G0 Voltage Current draw	R = 0...1000 Ω, G, G0 Stroke / rotation proportional to R 90° ¹⁾ 0° ¹⁾ Max. AC 24 V ± 20% Max. DC 24 V + 20% / -15% ≤ 0.1 mA
Position feedback	Position feedback U SAL61.. Load impedance Load	DC 0...10 V >10 kΩ res. Max. 1 mA
Connecting cable	Wire cross-sectional areas	0.75...1.5 mm ² , AWG 20...16 ²⁾
Connecting cable	Cable entries	2 entries Ø 20.5 mm (for M20) 1 entry Ø 25.5 mm (for M25)

Degree of protection	Housing from vertical to horizontal	IP54 as per EN 60529 ³⁾
	Insulation class SAL31.. AC 230 V SAL61.. AC / DC 24 V SAL81.. AC / DC 24 V	As per EN 60730 II III III
Environmental conditions	Operation Climatic conditions Mounting location Temperature Humidity (noncondensing)	IEC 60721-3-3 Class 3K5 Indoors (weather-protected) -15...55 °C 5...95 % r.h.
	Transport Climatic conditions Temperature Humidity	IEC 60721-3-2 Class 2K3 -25...70 °C <95 % r.h.
	Storage Climatic conditions Temperature Humidity	IEC 60721-3-1 Class1K3 -15...55 °C 5...95 % r.h.
	Max. media temperature when mounted on valve	120 °C
Norms and Directives	Product standard	EN 60730-x
	Electromagnetic compatibility (Application)	For residential, commercial and industrial environments
	EU Conformity (CE)	CE1T4502X1 ⁴⁾
	RCM Conformity	A5W00002575 ⁴⁾
	EAC Conformity	Eurasia Conformity for all SAL..
	UL, cUL AC 230 V AC / DC 24 V	- UL 873 http://ul.com/database . File number E35198
Environmental compatibility		The product environmental declaration CE1E4502en ⁴⁾ contains data on environmentally compatible product design and assessments (RoHS compliance, materials composition, packaging, environmental benefit, disposal).
Dimensions	-	See "Dimensions" (page 11)
Weight	Excl. packaging	See "Dimensions" (page 11)

¹⁾ Observe acting direction of DIL switches

²⁾ AWG = American wire gauge

³⁾ Also with weather shield ASK39.1

⁴⁾ The documents can be downloaded from <http://siemens.com/bt/download>.

Accessories ¹⁾	Potentiometer ASZ7.5	Voltage DC 10 V Current rating <4 mA
	Auxiliary switch ASC10.51 External supply line protection US installation, UL & cUL	Switching capacity AC 24...230 V, 6 (2) A, floating See section power supply AC 24 V class 2, 5 A general purpose

¹⁾ UL recognized component



Connection Diagrams

Internal Diagrams

SAL31..

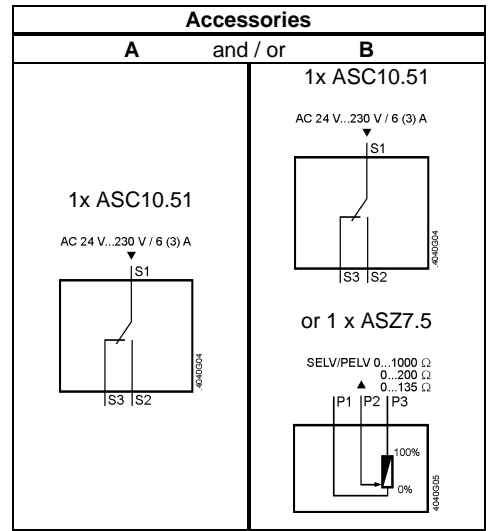
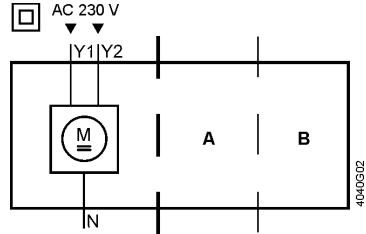

SAL61..

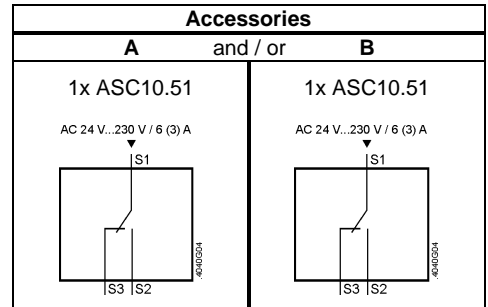
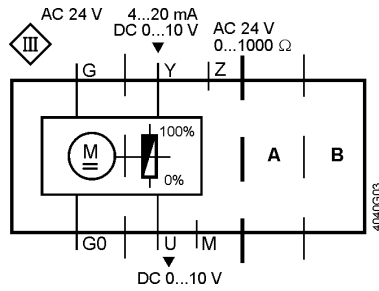

SAL81..

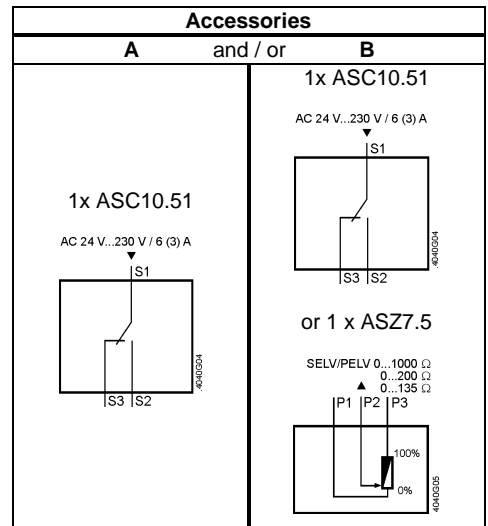
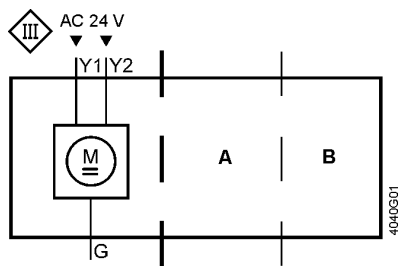

Connection terminals

SAL31..

AC 230 V, 3-position

N	System neutral (SN)
Y1	Positioning signal (actuator's spindle turns clockwise)
Y2	Positioning signal (actuator's spindle turns counter-clockwise)

SAL61..

AC/DC 24 V, DC 0...10 V / 4...20 mA / 0...1000 Ω

G0	System neutral (SN)
G	System potential (SP)
Y	Positioning signal for DC 0...10 V / 4...20 mA
M	Measuring neutral
U	Position feedback DC 0...10 V – (reference potential is M measuring neutral)
Z	Positioning signal forced control AC/DC ≤ 24 V, 0...1000 Ω

SAL81..

AC/DC 24 V, 3-position

G	System potential (SP)
Y1	Positioning signal (actuator's spindle turns clockwise)
Y2	Positioning signal (actuator's spindle turns counter-clockwise)

Connection terminals accessories

Auxiliary switch
ASC10.51

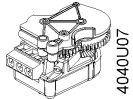

Adjustable switching points, AC 24...230 V

1	System potential (SP)
2	Closing (actuator's spindle turns clockwise)
3	Opening (actuator's spindle turns clockwise)

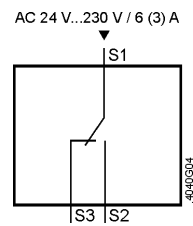

Potentiometer
ASZ7.5/..

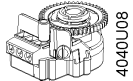

Adjustment of zero point, DC 10 V

1	Measuring neutral
2	0...x Ω
3	x...0 Ω

x = 135 Ω, 200 Ω; 1000 Ω

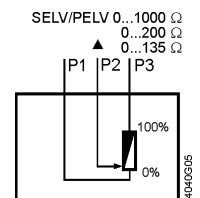

Connection Diagrams
SAL31..

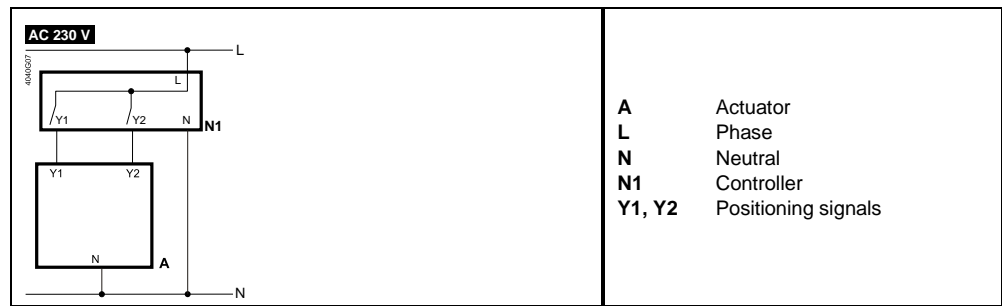

SAL61..

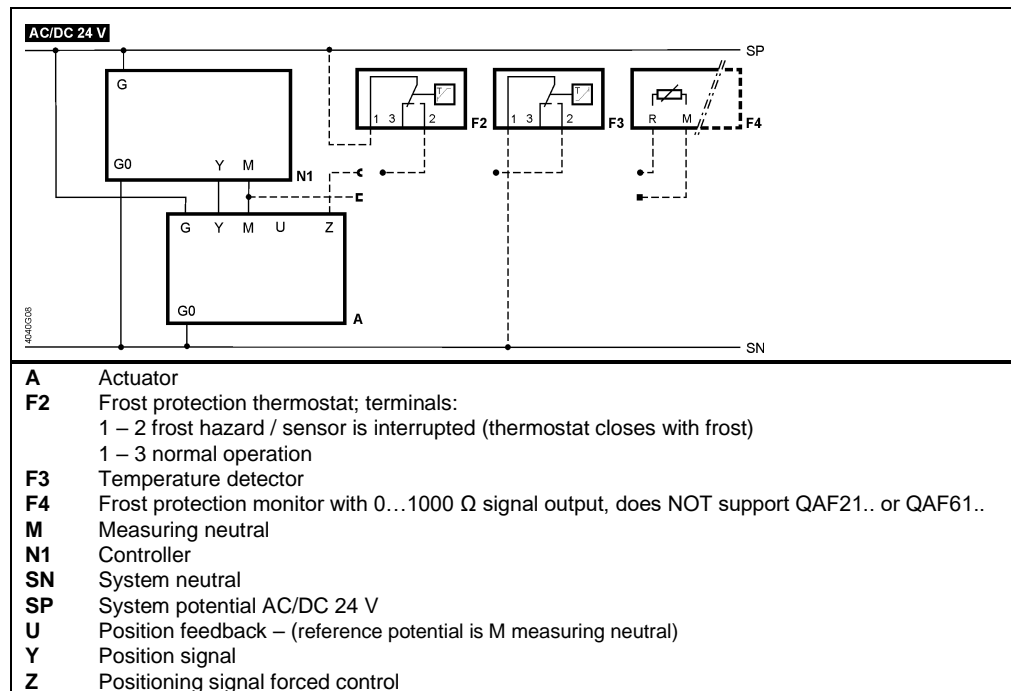

SAL81..

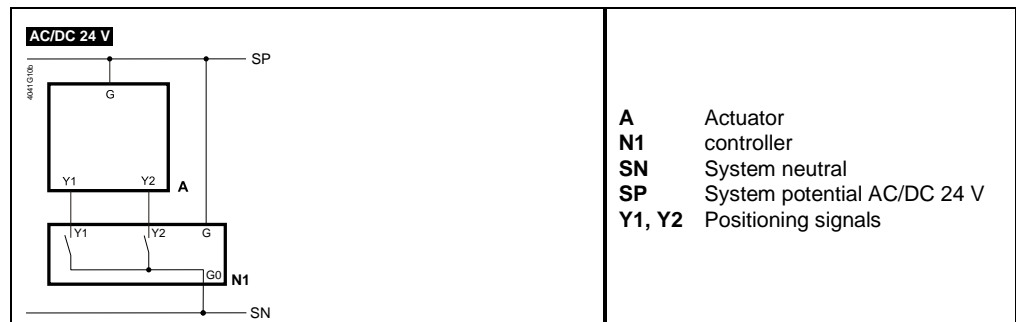

Dimensions

Dimensions in mm

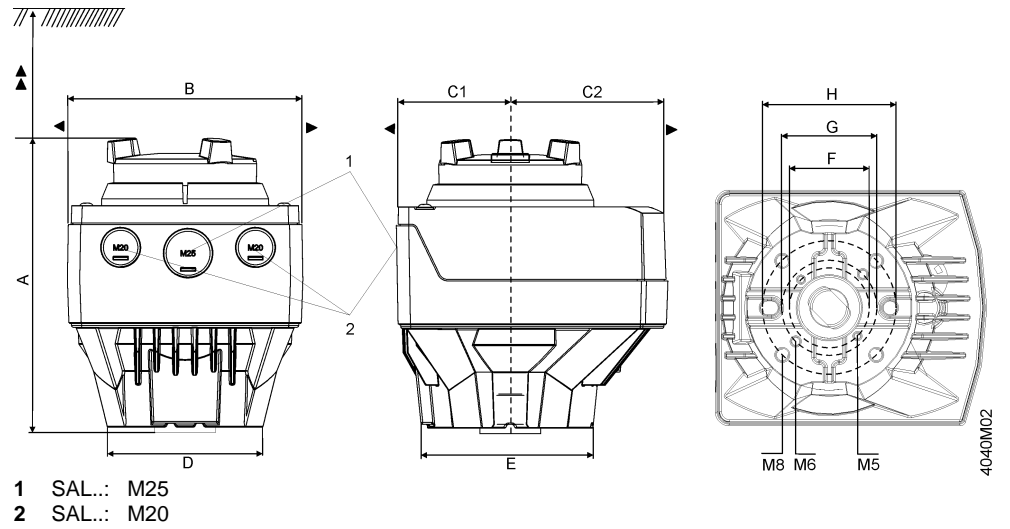

Type	A	B	C	C1	C2	D	E	F	G	H	▶	▶▶	kg		
													SAL..T10	SAL..T20	SAL..T40
SAL..	160	124	150	68	82	82	88	42	50	70	100	200	1.475	1.600	1.625
With ASK39.1	+25	154	300	200	100	-	-	-	-	-	-	-	1.710	1.835	1.860

With mounting set
ASK3..N

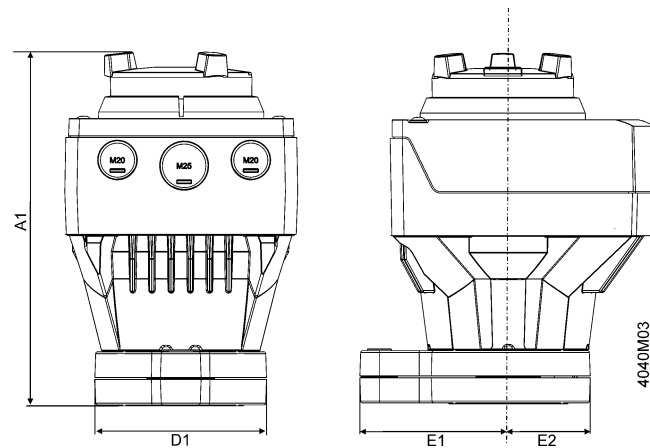

Type	A1	D1	E1	E2
SAL.. with ASK3..N	188	88	80	44
With ASK39.1	+25	-	-	-

Revision numbers

Product no.	Valid from rev. no.
SAL31.00T10	..E
SAL31.00T20	..D
SAL31.00T40	..B
SAL31.03T10	..E
SAL61.00T10	..E
SAL61.00T20	..D
SAL61.00T40	..B
SAL61.03T10	..E
SAL81.00T10	..E
SAL81.00T20	..D
SAL81.00T40	..B
SAL81.03T10	..E

Issued by
Siemens Switzerland Ltd
Smart Infrastructure
Global Headquarters
Theilerstrasse 1a
6300 Zug
Switzerland
Tel. +41 58-724 24 24

www.siemens.com/buildingtechnologies

© Siemens Switzerland Ltd, 2011

Technical specifications and availability subject to change without notice.