

Room sensors

QFA20..

For relative humidity and temperature

- Operating voltage AC 24 V or DC 13.5...35 V
- Signal output DC 0...10 V / 4...20 mA for relative humidity
- Signal output DC 0...10 V / 4...20 mA / LG-Ni 1000 or T1 for temperature
- Accuracy of ± 3 % r.h. within comfort range
- Range of use $-15...+50$ °C / 0...95 % r.h. (non-condensing)

Use

In ventilating and air conditioning plants to acquire

- relative humidity and
 - temperature
- in rooms.

The QFA20.. is used as a

- control sensor and
- measuring sensor for building automation and control systems or indicating units.

Type summary

Type reference	Temperature measuring range	Temperature signal output	Humidity measuring range	Humidity signal output	Operating voltage
QFA2000	None	None	0...100 %	active, DC 0...10 V	AC 24 V or DC 13.5...35 V
QFA2001	None	None	0...100 %	active, 4...20 mA	DC 13.5...35 V
QFA2020	0...50 °C	passive, LG-Ni 1000	0...100 %	active, DC 0...10 V	AC 24 V or DC 13.5...35 V
QFA2040	0...50 °C	passive, T1 (PTC)	0...100 %	active, DC 0...10 V	AC 24 V or DC 13.5...35 V
QFA2060	0...50 °C / -35...+35 °C / -40...+70 °C	active, DC 0...10 V	0...100 %	active, DC 0...10 V	AC 24 V or DC 13.5...35 V
QFA2060D					
QFA2071	0...50 °C / -35...+35 °C / -40...+70 °C	active, 4...20 mA	0...100 %	active, 4...20 mA	DC 13.5...35 V

Ordering and delivery

When ordering, please give name and type reference, e.g.:
Room sensor QFA2060D.

Equipment combinations

All systems or devices capable of acquiring and handling the sensor's DC 0...10 V, 4...20 mA, LG-Ni 1000 or T1 output signal.

When using the sensors for minimum or maximum selection, for averaging, or to calculate enthalpy, enthalpy difference, absolute humidity, and dew point, we recommend to use the SEZ220 signal converter (see Data Sheet N5146).

Mode of operation

Relative humidity

The sensor acquires the relative humidity in the room via its capacitive humidity sensing element whose electrical capacitance changes as a function of the relative humidity. The electronic measuring circuit converts the sensor's signal to a continuous DC 0...10 V or 4...20 mA signal, which corresponds to 0...100 % relative humidity.

Temperature

The sensor acquires the temperature in the room via its sensing element whose electrical resistance changes as a function of the temperature.

This change in resistance is converted to an active DC 0...10 V or 4...20 mA output signal, corresponding to a temperature range of 0...50 °C, -35...+35 °C, or -40...+70 °C. The measuring range can be selected. The temperature is provided as a simulated passive LG-Ni 1000 or T1 output signal (\cong 0...50 °C) as an alternative to the active output signal.

Simulated passive output signal

The measuring current from systems/devices to acquire the electrical resistance of the passive sensor differs greatly and impacts self-heating of the temperature sensing element at the end of the measuring tip. To compensate the impact, the passive output signal is simulated with an electronic circuit.

Sensing elements, simulated

Characteristic LG-Ni 1000

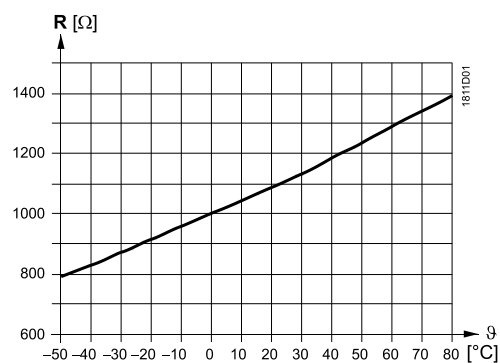

Characteristic T1 (PTC)

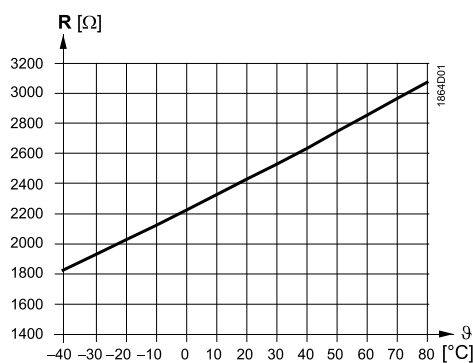

Legend

R Resistance value in Ohm
 θ Temperature in degrees Celsius

Burden diagram

Output signal, terminal I1 / I2

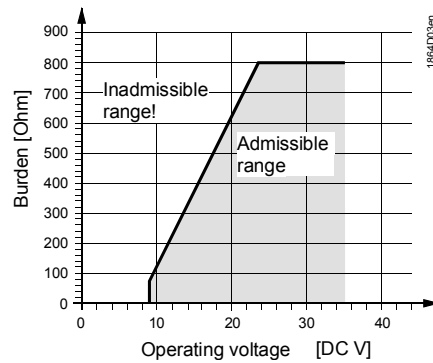

Mechanical design

The room sensors have been designed for wall mounting. They are suitable for use with most commercially available recessed conduit boxes. The cables can be introduced from the rear (concealed wiring) or from below or above (surface-run wires) through knock-out openings.

The two-part housing comprises a casing and a baseplate. Both snap together but can be detached again.

The measuring circuit, the sensing elements and the setting element are located on the printed circuit board inside the casing.

The baseplate carries the connecting terminals.

Measured value display

The type QFA2060D provides the measured values on its LCD display. The following measured values are displayed alternately in intervals of 5 s:

- Temperature: in °C or °F
- Humidity: in % r.h.

Setting element

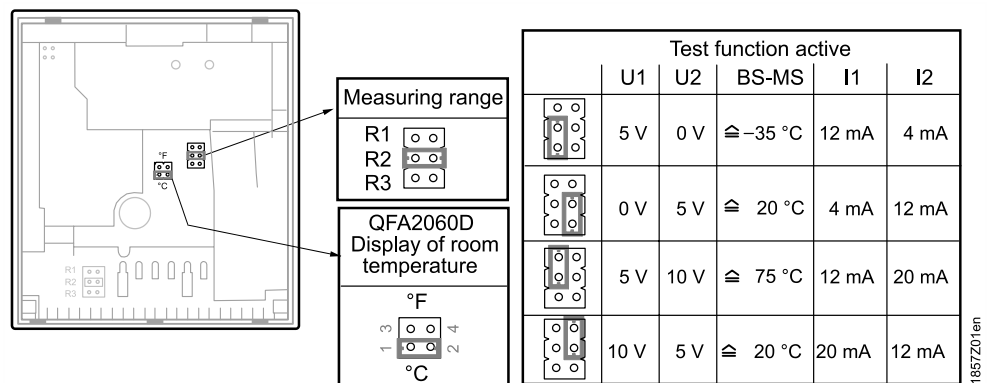

The setting elements are located in the casing. A setting element consists of 6 pins and a jumper. It is used for selecting the required temperature measuring range and for activating the test function. Types with LCD display have a second setting element with 4 pins and a jumper.

The different jumper positions have the following meaning:

- *For the passive temperature measuring range (QFA2020, QFA2040):*
Jumper in the middle position (R2) = LG-Ni 1000 or T1 (0...50 °C)
- *For the active temperature measuring range:*
Jumper in the upper position (R1) = -35...+35 °C,
Jumper in the middle position (R2) = 0...50 °C (factory setting),
Jumper in the lower position (R3) = -40...+70 °C

- *For activating the test function:*
Jumper in the vertical position: The values according to the table "Test function active" will be made available at the signal output.
- *For the measured value display (QFA2060D)*
 - Jumper horizontal, in the upper position = °F
 - Jumper horizontal, in the lower position = °C (factory setting)

Malfunction

- Should the temperature sensor become faulty a voltage of 0 V (4 mA) will be applied at signal output U2 (I2) or signal output BS-MS becomes high impedance (>1 MΩ) after 60 seconds, and the humidity signal at signal output U1 (I1) will reach 10 V (20 mA).
- Should the humidity sensor become faulty a voltage of 10 V (20 mA) will be applied at signal output U1 (I1) after 60 seconds, and the temperature signal will remain active.

Engineering notes

Room sensors with active outputs have a high power loss, which can influence temperature measurement. The degree of influence depends on the operating voltage and is compensated in the Symaro™ room sensors for an operating voltage of AC 24 V or DC 24 V. Over- or undercompensation may occur for other operating voltages.

Furthermore, the measuring accuracy is impacted by the following factors:

- Prevailing air flow
- Wall surface (rough, smooth)
- Wall texture (wood, plaster, concrete, brick)
- Wall type (interior, exterior).

This application-specific measuring inaccuracy is constant for an installed sensor after approx. 1 operating hour, and it can be adjusted as needed in a higher system (e.g. controller). No correction on the local LCD.

A transformer for safety extra low-voltage (SELV) with separate windings for 100 % duty is required to power the sensor. When sizing and protecting the transformer, the local safety regulations must be complied with.

When sizing the transformer, the power consumption of the room sensor must be taken into consideration.

For correct wiring of the sensor, refer to the Data Sheets of the devices with which the sensor is used.

The permissible line lengths must be considered.

Cable routing and cable selection

It must be considered for routing of cables that the longer the cables run side by side and the smaller the distance between them, the greater the electrical interference.

Shielded cables must be used in environments with EMC problems.

Twisted pair cables are required for the secondary supply lines and the signal lines.

Note to QFA2071

Terminals G1(+) and I1(–) of the humidity output must always be connected to power, even if only terminals G2(+) and I2(–) of the temperature output are used!

G1(+) and I1(–) are galvanically isolated towards G2(+) and I2(–).

Mounting notes

Location	<p>Inside wall (not on outside wall!) of the room to be air conditioned; not in recesses, behind curtains, above or close to heat sources or shelves not on walls behind which a chimney is located. The unit must not be exposed to spot lights or direct solar radiation. The unit must not be exposed to spot lights or direct solar radiation.</p> <p>Install the sensor in the occupied space about 1.5 m above the floor and at least 50 cm from the next wall.</p> <p>The end of the conduit at the sensor must be sealed to prevent false measurements due to draughts through the conduit.</p>
Mounting instructions	Mounting instructions are printed on the inner side of the package.
Chemical vapors	It is of great importance to understand that a humidity sensor is a sensitive measure device and needs to be handled with care. Chemical vapors at high concentration in combination with long exposure times may offset the sensor reading.

Commissioning notes



Check wiring before switching on power. The temperature measuring range must be selected on the sensor, if required.

Wiring and the output signals can be checked by making use of the test function (refer to "Mechanical design").

We recommend not to use voltmeters or ohmmeters directly at the sensing element. In the case of the simulated passive output signals, measurements with commercially available meters cannot be made (measuring current too small).

Disposal



The devices are considered electronics devices for disposal in term of European Directive 2012/19/EU and may not be disposed of as domestic waste.

- Dispose of the device via the channels provided for this purpose.
- Comply with all local and currently applicable laws and regulations.

Technical data

Power supply	Operating voltage	AC 24 V \pm 20 % or DC 13,5...35 V (SELV) or AC/DC 24 V class 2 (US)
	Frequency	50/60 Hz at AC 24 V
	External supply line protection	Fuse slow max. 10 A or Circuit breaker max. 13 A Characteristic B, C, D according to EN 60898 or Power source with current limitation of max. 10 A
	Power consumption	
	QFA2...	≤ 0.4 VA
	QFA2001	≤ 0.7 W
	QFA2071	≤ 1.4 W
	QFA2020, QFA2040	≤ 1 VA
Cable lengths for measuring signal	Perm. cable lengths	See data sheet for the device handling the signal
Functional data of humidity sensor	Range of use	0...95 % r.h. (non-condensing)
	Measuring range	0...100 % r.h.
	Measuring accuracy (*) at 23 °C and AC/DC 24 V and at	
	0...95 % r.h.	± 5 % r.h.
30...70 % r.h.	± 3 % r.h.	
	(*) Values for output signal sensor types with 0-10 V signal: only for AC 24 V and 4...20 mA signal: only for DC 24 V	
	Temperature dependency	≤ 0.1 % r.h./°C
	Time constant	< 20 s
	Output signal, linear (terminal U1)	DC 0...10 V $\hat{=}$ 0...100 % r.h., max. 1 mA
	Output signal, linear (terminal I1) Burden	4...20 mA $\hat{=}$ 0...100 % r.h. refer to "Mode of operation"
	Range of use	-15...+50 °C
Functional data of temperature sensor with QFA2060(D), QFA2171	Measuring range	0...50 °C (R2 = factory setting), -35...+35 °C (R1) or -40...+70 °C (R3)
	Sensing element	NTC 10k
	Measuring accuracy at AC/DC 24 V and at	
	23 °C	± 0.3 K
15...35 °C	± 0.7 K	
-35...+50 °C	± 1 K	
	Time constant	8.5 min (depending on air movement and thermal coupling to the wall)
	Output signal, linear (terminal U2)	DC 0...10 V $\hat{=}$ 0...50 °C / -35...+35 °C / -40...+70 °C max. 1 mA
	Output signal, linear (terminal I2) Burden	4...20 mA $\hat{=}$ 0...50 °C / -35...+35 °C / -40...+70 °C refer to "Mode of operation"

Functional data of temperature sensor with QFA2020, QFA2040	Measuring range	0...50 °C
	Sensing element simulated, corresponding to	
	QFA2020	LG-Ni 1000
	QFA2040	T1 (PTC)
	Measuring accuracy at AC/DC 24 V and at	
15...35 °C	±0.7 K	
-35...+50 °C	±1 K	
Time constant	8.5 min (depending on air movement and thermal coupling to the wall)	
Perm. measuring current with	QFA2020	1.18...4.21 mA
	QFA2040	0.53...1.89 mA
Degree of protection	Protection degree of housing	IP30 according to EN 60529
	Protection class	III according to EN 60730
Electrical connections	Screw terminals for	1 × 2.5 mm ² or 2 × 1.5 mm ²
Environmental conditions	Operation to	IEC 60721-3-3
	Climatic conditions	Class 3K5
	Temperature (housing with electronics)	-15...+50 °C
	Humidity	0...95 % r. h (non-condensing)
	Mechanical conditions	Class 3M2
Transport to	Climatic condition	IEC 60721-3-2
	Temperature	Class 2K3
	Humidity	-25...+70 °C
	Humidity	<95 % r.h.
	Mechanical conditions	Class 2M2
Materials and colors	Housing front	ASA + PC, NCS S 0502-G (white) equates to RAL9010
	Bottom section of housing	ASA + PC, NCS 2801-Y43R (grey) equates to RAL7035
	Base	PC, NCS 2801-Y43R (grey) equates to RAL7035
	Sensor (complete assembly)	Silicone-free
	Packaging	Corrugated cardboard
Standards, directives, and approvals	Product standard	EN 60730-1 Automatic electrical controls for household and similar use
	Electromagnetic compatibility (Applications)	For use in residential, commerce, light-industrial and industrial environments
	EU Conformity (CE)	CE1T1857xx ^{*)}
	RCM Conformity	CE1T1961en_C1
	EAC Conformity	Eurasia Conformity
	UL	UL 873, http://ul.com/database
	Environmental compatibility	The product environmental declaration CE1E1961 ^{*)} contains data on environmentally compatible product design and assessments (RoHS compliance, materials composition, packaging, environmental benefit, disposal).
Weight	Incl. packaging	
	Without LCD display	Approx. 0.130 kg
	With LCD display	Approx. 0,150 kg

*) The documents can be downloaded from <http://siemens.com/bt/download>.

Internal diagram

QFA2060 QFA2060D

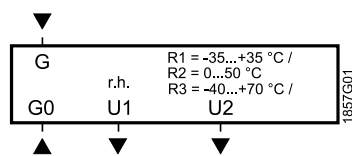

QFA2020, QFA2040 (as of series B) QFA2000

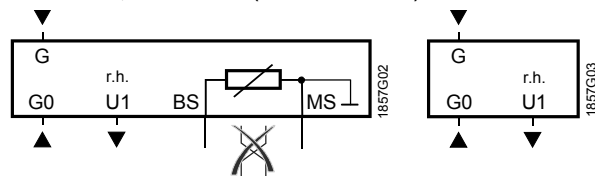

QFA2001

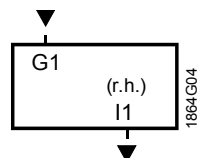

QFA2071

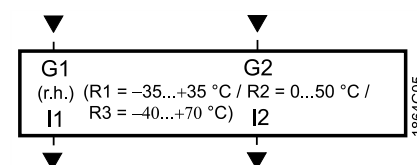

- G, G0 Operating voltage AC 24 V (SELV) or DC 13.5...35 V
 G1, G2 Operating voltage DC 13.5...35 V
 U1 Signal output DC 0...10 V for relative humidity 0...100 %
 U2 Signal output DC 0...10 V for temperature range 0...50 °C (R2 = factory setting),
 -35...+35 °C (R1) or -40...+70 °C (R3)
 I1 Signal output 4...20 mA for 0...100 % r.h.
 I2 Signal output 4...20 mA for temperature range 0...50 °C (R2 = factory setting),
 -35...+35 °C (R1) or -40...+70 °C (R3)
 BS, MS Signal output LG-Ni 1000 or T1 (passive, simulated) for temperature range 0...50 °C;
 the wires must not be interchanged

Note on connection terminals of the QFA2071:

Terminals G1(+) and I1(-) of the humidity output must always be connected to power, even if only terminals G2(+) and I2(-) of the temperature output are used!
 G1(+) and I1(-) are galvanically isolated towards G2(+) and I2(-).

Dimensions

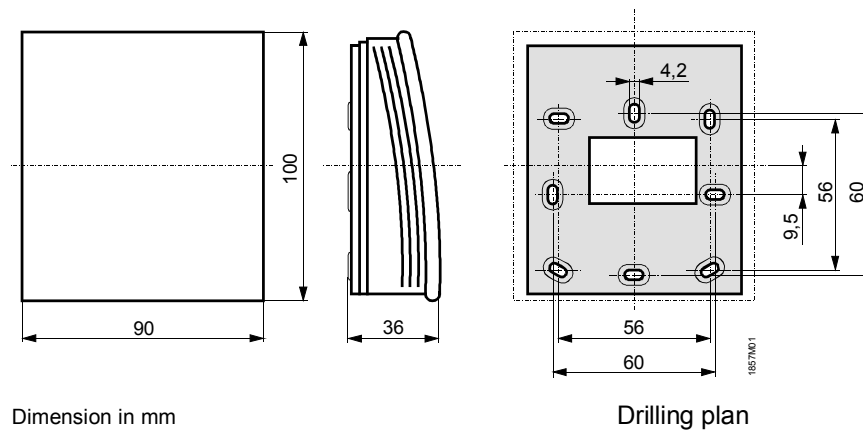

Dimension in mm

Drilling plan