

9215P01_01

Desigo™ PX

Automation stations, compact model

PXC...D

PXC12.D	PXC22.D	PXC22.1.D	PXC36.1.D
PXC12-E.D	PXC22-E.D	PXC22.1-E.D	PXC36.1-E.D

- Freely programmable compact automation stations for HVAC and building services.
- Communications
 - BACnet/IP
 - BACnet/LonTalk
- BTL label (BACnet communication passed the BTL test)
- Comprehensive management and system functions (alarm management, time scheduling, trends, remote management, access protection etc.)
- 12, 22, or 36 physical inputs / outputs per automation station
- PXC22.1... and PXC36.1...: Extendable with TX-I/O and / or TX Open
- For stand-alone applications or for use within a device or system network
- System or web operation via system network

Validity

*This data sheet is valid for firmware Desigo V6. 1. and higher.
For older devices / firmware see data sheet CM1N9215en_16.*

Functions

Compact, freely programmable automation stations for HVAC and building control systems.

- Management functions (alarm management with alarm routing, schedulers, trend functions, remote management, access protection with individually defined user profiles and categories).
- For stand-alone applications or for use within a device or system network.
- BTL-tested BACnet communications on LonTalk, PTP or IP, compliant with BACnet standard (Rev. 1.12 -for Desigo V6.0 and later) including B-BC profile.
- AMEV profiles AS-A and AS-B to recommendation "BACnet 2011 - Version 1.2 (for Desigo V6.0 and later)"
- Freely programmable, using the D-MAP programming language (close resemblance to CEN standard 11312). All function blocks, available in libraries, can be graphically connected.
- Engineering and commissioning using the Desigo Xworks Plus tool.
- Scalable range of touch panels, Web solutions and operator units
- Direct connection of field devices; the devices provide power supply for inputs and outputs as well as for active sensors.
- Low voltage protection and start-up management to protect the devices against fluctuating voltage.

Types

Automation stations	PXC12-E.D ¹⁾	PXC22-E.D ¹⁾	PXC22.1-E.D ¹⁾	PXC36.1-E.D ¹⁾
	PXC12.D ²⁾	PXC22.D ²⁾	PXC22.1.D ²⁾	PXC36.1.D ²⁾
Total number of inputs / outputs (Onboard)	12	22	22	36
Number of digital inputs (DI)	2	-	-	4
Number of universal inputs / outputs (UIO) whereof UIO supporting Q250 (DC 0/24 V)	8 (4)	16 (4)	16 (4)	24 (6)
Number of relay outputs (DO)	2	6	6	8
Number TX-I/O data points ³⁾			16	16
Number of physical data points ³⁾ (Onboard + TX-I/O)	-	-	38	52
Number of TX Open modules	-	-	5	5
Number of data points ³⁾ (Onboard + TX-I/O + TX Open)	-	-	400	400

¹⁾ Communications BACnet / IP

²⁾ Communications BACnet / LonTalk

³⁾ Communications island bus

Input and output configuration

UIO	<p>Universal input and output, suited for the following signal types:</p> <ul style="list-style-type: none"> • Passive sensor LG-Ni 1000, Ni 1000, Pt 1000, T1 • Active sensor DC 0...10 V • Volt-free binary contact for signaling function • Counter up to 20 Hz (C) • Analog output DC 0...10 V • Part of the UIOs can be configured for binary switching with a load of 24 V / 20mA. PXC12/22..D: 4 UIOs; PXC36: 6 UIOs
DI	Binary input for signaling function 7 mA, DC 20...25 V
DO	Relay output AC 230 V / 2 A for binary switching, switchover contact

Device combinations with automation stations

TX-I/O devices ¹⁾		Type	Data sheet
Digital input module	8 or 16 I/O points	TXM1.8D, TXM1.16D	CM2N8172
Universal module	without / with local operation and LCD	TXM1.8U, TXM1.8U-ML	CM2N8173
Super universal mod.	without / with local operation and LCD	TXM1.8X, TXM1.8X-ML	CM2N8174
Relay module	without / with local operation	TXM1.6R, TXM1.6R-M	CM2N8175
Resistance measuring module (for Pt100 4-wire)		TXM1.8P	CM2N8176
Relay module bistable		TXM1.6RL	CM2N8177
Triac module		TXM1.8T	CM2N8179
Power supply module 1.2 A, Fused 10A		TXS1.12F10	CM2N8183
Bus interface module, Fused 10A		TXS1.EF10	CM2N8183
Island bus expansion module		TXA1.IBE	CM2N8184
TX Open module	up to 40 / 160 data points	TXI2-S.OPEN, TXI2.OPEN	CM1N8185

¹⁾ The TXM1... and TX Open require a TXS1.12F10 power supply module

Desigo Control point

	Type	Data sheet
BACnet touch panels with integrated data management and web server functionality:		
7.0 "	PXM30.E	A6V10933111
10.1 "	PXM40.E	A6V10933114
15.6 "	PXM50.E	A6V10933114
BACnet/IP web server with standard functionality	PXG3.W100-1	A6V10808336
BACnet/IP web server with enhanced functionality	PXG3.W200-1	
Client touch panels with data management in the PXG3.Wx00-1 web server		
7.0 "	PXM30-1	A6V10933111
10.1 "	PXM40-1	A6V10933114
15.6 "	PXM50-1	A6V10933114

Operator units for automation stations

	Type	Data sheet
Local operating unit	PXM10	CM1N9230
Network operator unit in a BACnet/IP network ¹⁾	PXM20-E	CM1N9234
Network operator unit in a BACnet/LonTalk network ¹⁾	PXM20	CA1N9231
Cable (3 m) between PXM10 or PXM20 and PXC...D	PXA-C1	--
Room operator units ²⁾	QAX30.1, QAX31.1	CA2N1741
	QAX32.1	CA2N1641
	QAX33.1	CA2N1642
	QAX34.3 ³⁾	CM2N1640
	QAX84.1/PPS2	CA2N1649
PXC22.1-E.D, PXC36.1-E.D: Generic web operation	integrated	

¹⁾ In the case of a PXC...D automation station, one PXM10 and one PXM20 operator unit may be connected, but not twice the same type.

²⁾ Up to 5 QAX3... room units can be connected to all compact automation stations.

³⁾ The QAX34. room unit only supports address 1.

Accessories

Adapter for firmware download	PXA-C2
-------------------------------	--------

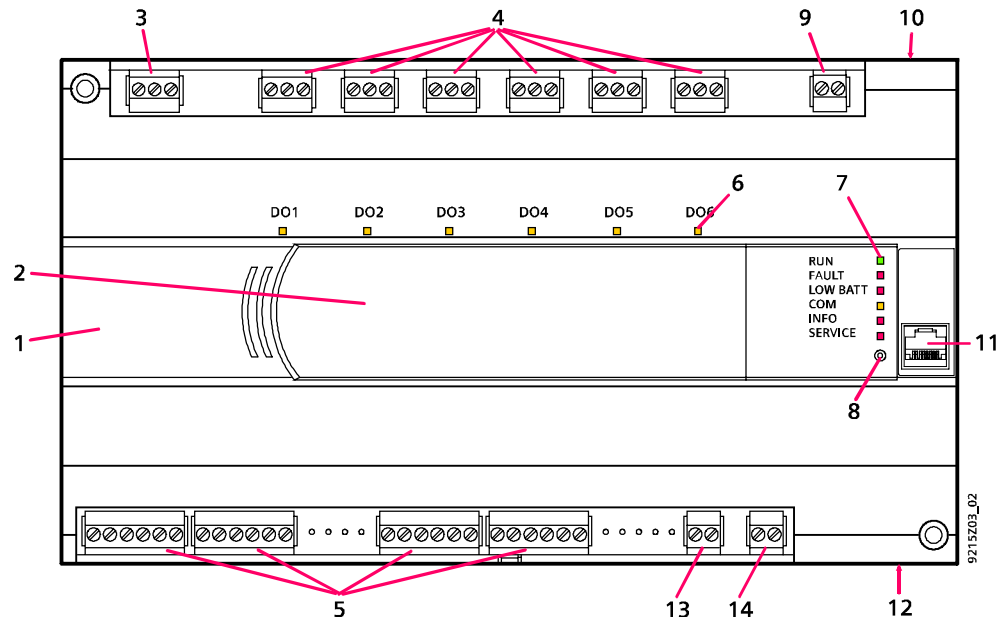

1	Plastic housing
2	Front cover
3	Plug-in screw terminal block (operating voltage)
4	Plug-in screw terminal block (relays)
5	Plug-in screw terminal block (inputs, outputs)
6	LED indicators for relay outputs
7	LED indicators for device and system status
8	Service pin (Network identification)
9	Plug-in screw terminal block (LONWORKS bus, PXC....D only)
10	Network interface RJ45 (BACnet / IP, PXC...-E.D only)
11	RJ45 Interface for operator unit and tool (RJ45, PXC....D only)
12	RJ45 interface for operator unit
13	Plug-in screw terminal block (room units)
14	Island bus plug (PXCxx.1 types only)

Positions of keys and batteries

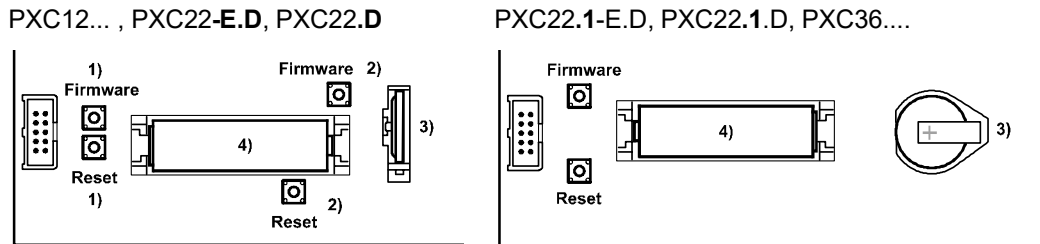

- 1) Firmware and Reset pins for PXC12-E.D and PXC22-E.D
- 2) Firmware and Reset pins for PXC12.D and PXC22.D
Pressing the **reset pin** forces a restart.
If the **Firmware pin** is pressed during a restart (reset) the current D-MAP program is deleted from the FLASH.
- 3) Battery for real time clock (Lithium Typ CR2032): Backup during power breakdown
- 4) Battery for trend data and present parameters (Lithium Typ FR6/AA):
Backup during power breakdown

LED indicators

Each **relay output** has a yellow status LED

The **other LEDs** have the follow meanings:

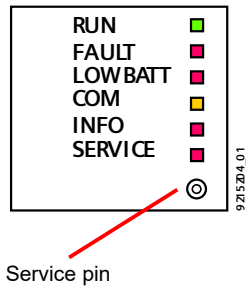

LED	Color	Activity	Function
RUN	Green	Continuously off Continuously on	No supply Supply OK
FAULT	Red	Continuously off Continuously on Quick flashes	OK Fault Missing / Corrupt Firmware
LOW BATT	Red	Continuously off Continuously on	Battery ok Battery low - replace ¹⁾
COMM	Yellow	Continuously off Continuously on Flashing	No Link to switch Link to switch Communication
INFO	Red		Freely programmable
SERVICE (Ethernet)	Red	Continuously off Continuously on Flashing Flashing acc. to wink command pattern ²⁾	OK No Link to switch or DHCP server No IP Address configured Physical identification of automation station after receiving wink command
SERVICE (LONWORKS bus)	Red	Continuously off Continuously on Flashing Flashing acc. to wink command pattern ²⁾	LONWORKS node is configured LONWORKS chip defective or service key was pressed again LONWORKS node is not configured Physical identification of automation station after receiving wink command

Battery change

¹⁾ If one of the batteries has low charge the "LOW BATT" LED lights up and the automation station sends a system event.

Remaining battery life after a "Low batt" event:

- Battery for real time clock (Type CR2032): several days.
- Battery for trend data and present parameters (Type AA Lithium): approx. 15 hrs.
Alkaline: several days.
- As long as there is an external power supply, the battery may be removed for unlimited time.
- To prevent hardware damage by electrostatic discharge (ESD), a wrist strap with earth cable must be used during the battery change.
- Note the special disposal notes on Li batteries.



Caution!

²⁾ Wink command rhythm pattern:

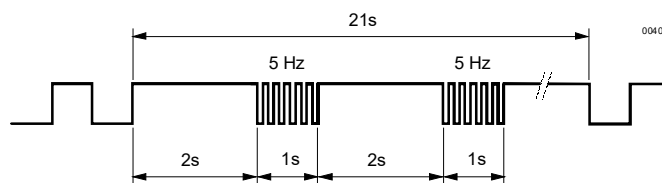

Technical data

General device data	Operating voltage		AC 24 V ± 20% (SELV / PELV) or AC 24 V class 2 (US)										
	Operating frequency		50/60 Hz										
	Power Consumption (depending on field devices)		PXC12....D max.24 VA PXC22....D max.26 VA PXC36....D max.35 VA										
	Internal fuse		5 A										
Operating data	Processor	PXC12/22....D PXC36....D	Motorola Power PC MPC852T Motorola Power PC MPC885										
	Memory	PXC12/22....D PXC36....D	16MB SDRAM / 8MB FLASH (24MB total) 64MB SDRAM / 16MB FLASH (80MB total)										
	Accuracy class		0.5										
	Scan cycle		Max. 1 s										
Data backup in case of power failure	Battery Backup of Realtime Clock Lithium type CR2032 (field replaceable)		Battery operation (cumulative): 10 years Without load: 10 years										
	Battery Backup of SDRAM 1x AA: (field replaceable)		Battery operation (cumulative): min. 2 weeks Without load: Lithium 10 years										
	<ul style="list-style-type: none"> Lithium Type FR6/AA: PXCxx.1; PXC12/22...D series K and later; PXC36...D series D and later Alkaline: PXC12/22...D up to series H; PXC36...D up to series C 		Without load: Alkaline 4 years										
Interface, room units	Interface type		PPS2										
	Supply class		4										
	PPS2 baud rate		4.8 kBit/s										
Interface, island bus	Pluggable screw terminal (CS, CD)		Short circuit proof										
	<i>Additionally, ⊥ (Terminal 82) must be connected to conductor ⊥ (system neutral of the island bus system).</i>												
Interfaces, communication	<table border="1"> <thead> <tr> <th>PXC....D</th> <th>PXC...-E.D</th> </tr> </thead> <tbody> <tr> <td>Building Level Network LonWORKS FTT Transceiver (Screw terminals)</td> <td>10 Base-T / 100 Base-TX IEEE802.3, Auto-sensing (RJ45)</td> </tr> <tr> <td>Local Communication (HMI, Tool) (RJ45)</td> <td>--</td> </tr> <tr> <td>Local Communication (HMI) (RJ45)</td> <td>• PXM10 (RS-232)</td> </tr> <tr> <td>One PXM10 operator unit and one PXM20 per automation station may be connected. But not twice the same type.</td> <td>One PXM10 on RJ45</td> </tr> </tbody> </table>		PXC....D	PXC...-E.D	Building Level Network LonWORKS FTT Transceiver (Screw terminals)	10 Base-T / 100 Base-TX IEEE802.3, Auto-sensing (RJ45)	Local Communication (HMI, Tool) (RJ45)	--	Local Communication (HMI) (RJ45)	• PXM10 (RS-232)	One PXM10 operator unit and one PXM20 per automation station may be connected. But not twice the same type.	One PXM10 on RJ45	
PXC....D	PXC...-E.D												
Building Level Network LonWORKS FTT Transceiver (Screw terminals)	10 Base-T / 100 Base-TX IEEE802.3, Auto-sensing (RJ45)												
Local Communication (HMI, Tool) (RJ45)	--												
Local Communication (HMI) (RJ45)	• PXM10 (RS-232)												
One PXM10 operator unit and one PXM20 per automation station may be connected. But not twice the same type.	One PXM10 on RJ45												
Binary inputs DI...	Contact voltage		DC 20 ... 25 V										
	Contact current		10 mA										
	Contact transfer resistance		Max. 200 Ω (closed)										
	Contact isolation resistance		Min. 50 kΩ (open)										

Universal inputs UI...	Configurable by software		
	A/D Resolution (analog in)	16 bits	
	Measured value inputs		
	Range	0 ... 11.0 V	
	Input resistance	100 k Ω against \perp	
	Sensor inputs		
	Temperature sensors		
	LG-Ni 1000, Ni 1000, Pt 1000, T1	Scaling range – 50 ... 150 °C	
	Sensor current (continuous current)	Approx. 2.1 mA	
	Resolution	0.2 K	
	Measuring error at 25 °C (Ni 1000, Pt 1000)	Max. 0.3 K (without cable and sensor)	
	Measuring error at 25 °C (T1)	Max. 1.0 K (without cable and sensor)	
	Signal inputs		
	Contact voltage	DC 20 ... 25 V	
	Contact current	7 mA	
	Contact transfer resistance	Max. 200 Ω (closed)	
	Contact isolation resistance	Min. 50 k Ω (open)	
Counter inputs			
Counting frequency (symmetric)	Max. 25 Hz		
Min. closing/opening time incl. bouncing	20 ms		
Max. bounce time	10 ms		
Counter memory	8 Bit		
	(0...255 \rightarrow max. cycle time 10 s at 25 Hz)		
	<i>Counter inputs faster than 1 Hz must be shielded if they are routed in the same trunking as analog inputs for more than 10 m.</i>		
Analog outputs AO...	Configurable by software		
	D/A Resolution (analog out)	10 bits	
	Proportional outputs		
Binary outputs BO	Output voltage range	0 ... 11.0 V	
	Output current	Max. 4 mA source, max. 1.5 mA sink	
	for off-board relays	only available on UIO 1...4 or 1...6 respectively	
	Output voltage range	0 / DC 24 V	
	Output current	20 mA	
	Load	$\geq 1000 \Omega$	
 Relay outputs DO... *)	Contact data for AC	Relay type	single pole, change-over contact
		Voltage range	min. AC 12V max. AC 250V
		Current, resistive load	max. 4A
		Current, inductive load (cos phi \geq 0.6)	max. 2A
		Switching current	min. 1mA at AC 250V
			min. 10mA at AC 12V
		Current on make	max. 20A during max. 10ms
			max. 10A during max. 1s
	Contact data for DC	Voltage range	min. DC 12V, max. DC 30V
		Current, resistive load	max. 3 A at DC 30 V
			min. 10mA at DC 12 V
		Current on make	max. 3 A
	Service life of contact for AC 250 V	With 0.1 A resistive	8 million switching operations
		With 0.5 A resistive	2 million switching operations
		With 4.0 A resistive (N/O)	0.2 million switching operations
	Reduction factor with inductive load (cos phi \geq 0.6)	0.6 (max. 2 A inductive)	
	External supply line protection	Slow-blow fuse max. 6 A	
		or	
		Circuit breaker max. 10 A	
		Characteristic B, C, D according to EN 60898	

*) The relay outputs are safely isolated from each other, from earth/cover and the remaining electronics (AC 24 V) in accordance with SELV and PELV specifications. The relay outputs can be used in mixing applications with AC 250 V and SELV / PELV circuits.

Plug-in screw terminal	Power supply and signals	Stranded of solid conductors, 0.25 ... 2.5 mm ² or 2 x 1.5 mm ²
Single cable lengths and cable types	Universal inputs UI... Binary inputs DI... Universal outputs AO... Relay outputs DO... Interface, room unit Cable type Capacitance per unit length Connecting cable Ethernet and PXM20-E Cable type Connecting cable LONWORKS bus Cable type Connecting cable PXM10	Max. 100m where A = 1 mm ² Max. 100 m with diameters ≥ 0.6 mm Max. 100m where A ≥ 1.5 mm ² Depends on load and local regulations Max. 125 m where A = 1.0 mm ² 2-core, twisted pair, unscreened Max. 56 nF/km Max. 100 m Standard at least CAT5 UTP (Unshielded Twisted Pair) or STP (Shielded Twisted Pair) See installation manual CA110396 CAT5 Max. 3 m
Protection data	Housing protection standard Protection class	IP 20 to EN 60529 II to EN 60730-1
Ambient conditions	Operation Climatic conditions Temperature Humidity Mechanical conditions Transport Climatic conditions Temperature Humidity Mechanical conditions	To IEC 60721-3-3 Class 3K5 0 ... 50 °C 5 ... 95 % rh (no condensation) Class 3M2 To IEC 60721-3-2 Class 2K3 -25 ... +70 °C 5 ... 95 % rh (no condensation) Class 2M2
Standards and directives and approvals	Product standard EN 60730-1 Product family standard EN 50491-x Electromagnetic compatibility (Applications) EU conformity (CE) UL certification (US) RCM-conformity (EMC) EAC conformity AMEV: Supports profiles AS-A and AS-B as of AMEV guideline "BACnet in public buildings" FCC	Automatic electrical controls for household and similar use General requirements for Home and Building Electronic Systems (HBES) and Building Automation and Control Systems (BACS) For use in residential, commerce, light-industrial and industrial environments CM1T9215xx *) UL916 http://ul.com/database CM1T9222en_C1 *) Eurasia conformity BACnet 2011 en, V1.1 CFR 47 Part 15 Class B
Environmental compatibility	Product environmental declaration (contains data on RoHS compliance, materials composition, packaging, environmental benefit, disposal) See "Dimensions"	CM1E9215 *)
Dimensions		
Weight	Type without packaging with packaging PXC12....D 750 830 PXC22.... D 754 834 PXC22.1.... D 1019 1095 PXC36.... D 1080 1160 PXC36.1.... D 1090 1166	

*) The documents can be downloaded from <http://siemens.com/bt/download>.

Connection terminals

PXC12.D

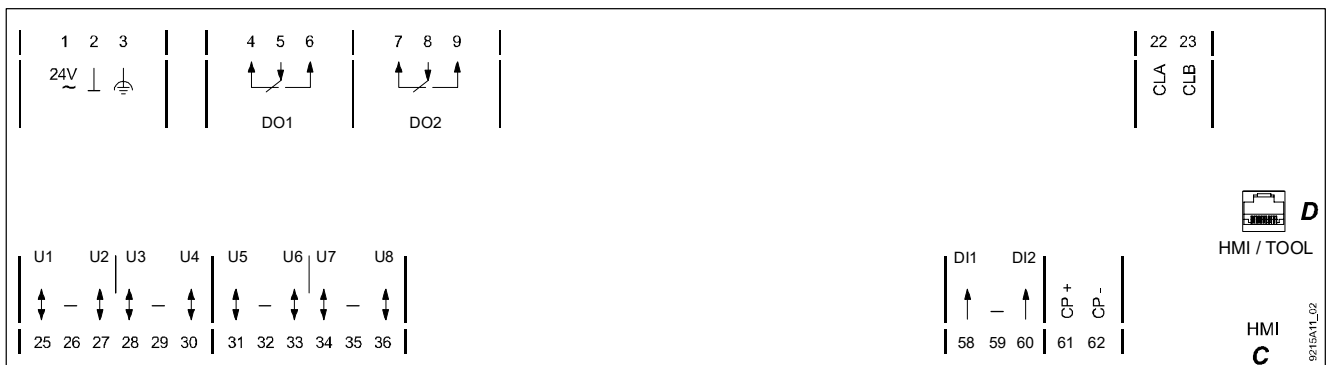

1, 2	24 V ~, ⊥	Operating voltage AC 24 V	
3		Functional earth	CFC IOAddr
4 ... 9	DO1, DO2	2 Digital outputs (Relays)	DO1: C=5.1
22, 23	CLA, CLB	LonWorks-Bus	
25 ... 30	U1...U4	4 Universal inputs / outputs with Q250	xx1: C=4.1 *)
31 ... 36	U5...U8	4 Universal inputs / outputs	xx5: C=1.1 *)
58 ... 60	DI1, DI2	2 Digital inputs	DI1: C=3.1
61, 62	CP+, CP-	PPS2 bus (for up to 5 QAX... room units)	
C	HMI	RJ45 socket for PXM10, PXM20	
D	HMI / Tool	RJ45 socket for PXM10, PXM20 and tool	

*) Signal type when no application is loaded (wiring test):

U1...U4: xx = Y10S, U5...U8: xx = R1K

PXC22.D

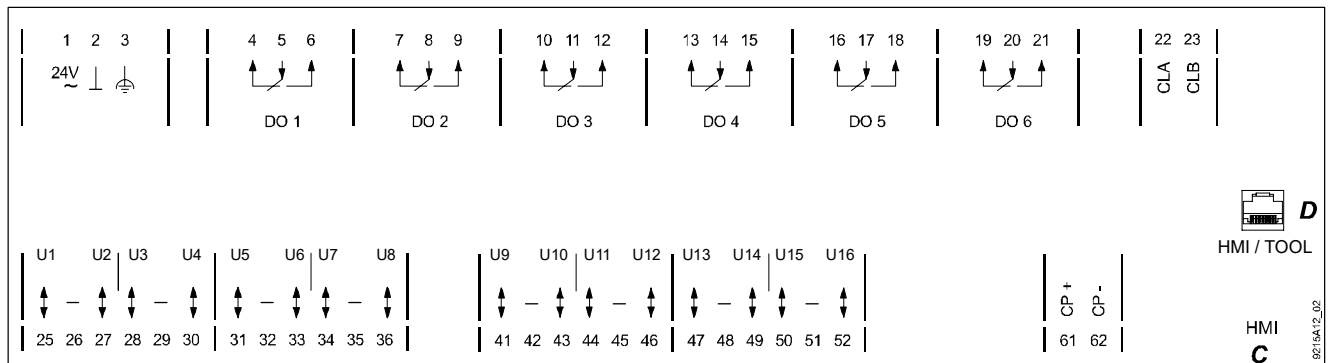

1, 2	24 V ~, ⊥	Operating voltage AC 24 V	
3		Functional earth	CFC IOAddr
4 ... 21	DO1 ... DO6	6 Digital outputs (Relays)	DO1: C=5.1
22, 23	CLA, CLB	LonWorks-Bus	
25 ... 30	U1 ... U4	4 Universal inputs / outputs with Q250	xx1: C=4.1 *)
31 ... 52	U5 ... U16	12 Universal inputs / outputs	xx5: C=1.1 *)
61, 62	CP+, CP-	PPS2 bus (for up to 5 QAX... room units)	
C	HMI	RJ45 socket for PXM10, PXM20	
D	HMI / Tool	RJ45 socket for PXM10, PXM20 and tool	

*) Signal type when no application is loaded (wiring test):

U1...U4: xx = Y10S, U5...U16: xx = R1K



Caution!

- **Observe the technical data for the relay outputs.**
- **Local installation regulations must be observed.**

PXC22.1.D

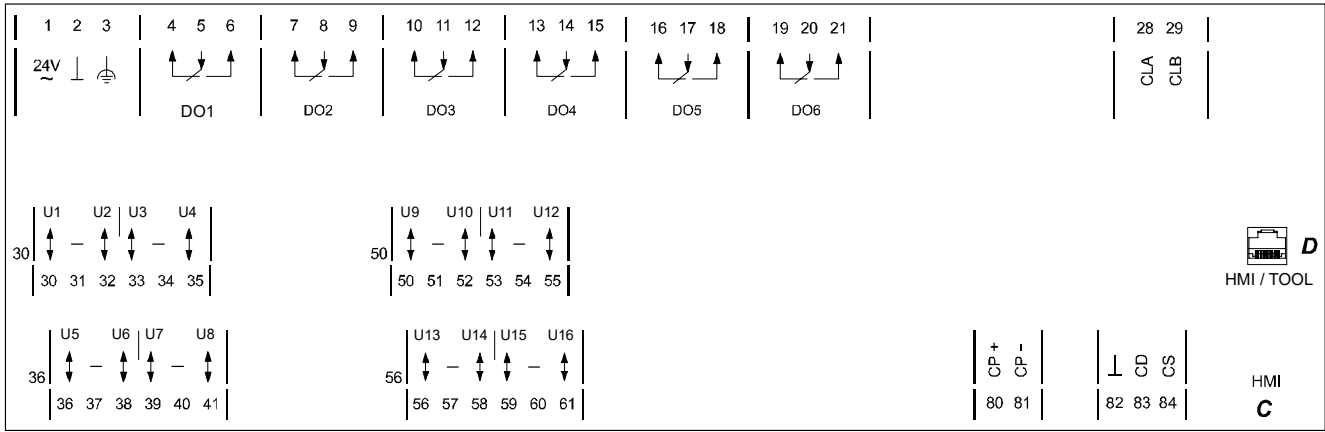

1, 2	24 V ~, ⊥	Operating voltage AC 24 V	
3	⊥	Functional earth	CFC IOAddr
4 ... 21	DO1 ... DO6	6 Digital outputs (Relays)	DO1: C=5.1
28, 29	CLA, CLB	LONWORKS bus	
30 ... 38	U1 ... U6	6 Universal inputs / outputs with Q250	xx1: C=4.1 *)
39 ... 61	U7 ... U16	10 Universal inputs / outputs	xx7: C=1.1 *)
80, 81	CP+, CP-	PPS2 bus (for up to 5 QAX... room units)	
82 ... 84	⊥, CD, CS	Island bus: <i>Additionally, the system neutral conductor ⊥ of the island bus system must be connected to ⊥ (Terminal 82).</i>	
C	HMI	RJ45 socket for PXM10, PXM20	
D	HMI / Tool	RJ45 socket for PXM10, PXM20 and tool	

PXC36.1.D

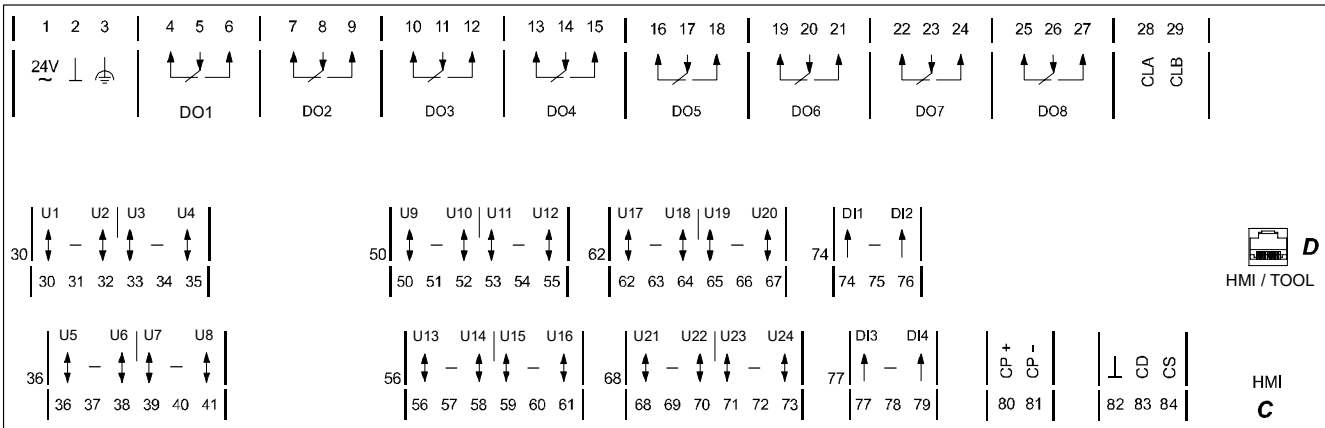

1, 2	24 V ~, ⊥	Operating voltage AC 24 V	
3	⊥	Functional earth	CFC IOAddr
4 ... 27	DO1 ... DO8	8 Digital outputs (Relays)	DO1: C=5.1
28, 29	CLA, CLB	LONWORKS bus	
30 ... 38	U1 ... U6	6 Universal inputs / outputs with Q250	xx1: C=4.1 *)
39 ... 73	U7 ... U24	18 Universal inputs / outputs	xx7: C=1.1 *)
74 ... 79	DI1 ... DI4	4 digital inputs	DI1: C=3.1
80, 81	CP+, CP-	PPS2 bus (for up to 5 QAX... room units)	
82 ... 84	⊥, CD, CS	Island bus: <i>Additionally, the system neutral conductor ⊥ of the island bus system must be connected to ⊥ (Terminal 82).</i>	
C	HMI	RJ45 socket for PXM10, PXM20	
D	HMI / Tool	RJ45 socket for PXM10, PXM20 and tool	

*) Signal type when no application is loaded (wiring test):
 U1...U6: xx = Y10S, U7...U24: xx = R1K



Caution!

- **Observe the technical data for the relay outputs.**
- **Local installation regulations must be observed.**

PXC12-E.D



1, 2	24 V ~, ⊥	Operating voltage AC 24 V	
3		Functional earth	CFC IOAddr
4 ... 9	DO1, DO2	2 Digital outputs (Relays)	DO1: C=5.1
25 ... 30	U1 ... U4	4 Analog inputs / outputs with Q250	xx1: C=4.1 *)
31 ... 36	U5 ... U8	4 Analog inputs / outputs	xx5: C=1.1 *)
58 ... 60	DI1, DI2	2 Digital inputs	DI1: C=3.1
61, 62	CP+, CP-	PPS2 bus (for up to 5 QAX... room units)	
A		Ethernet socket	
C	HMI	RJ45 socket for PXM10	

PXC22-E.D

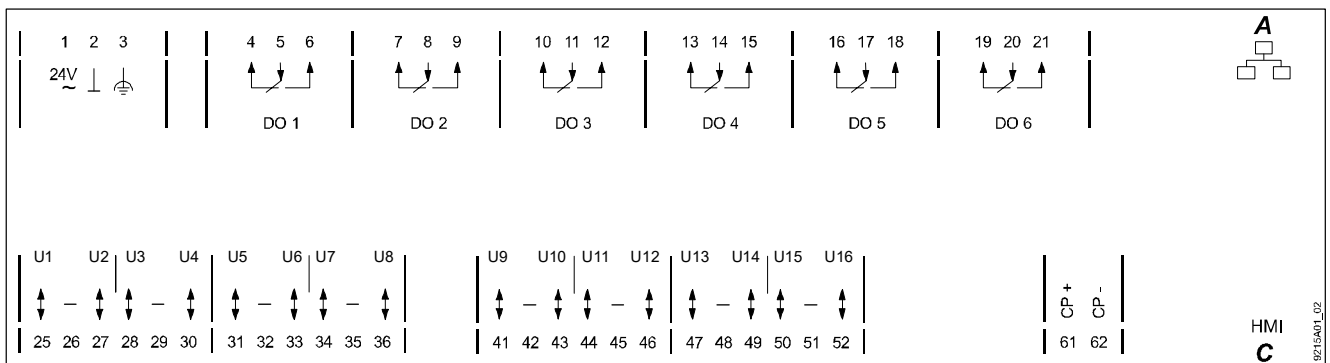

1, 2	24 V ~, ⊥	Operating voltage AC 24 V	
3		Functional earth	CFC IOAddr
4 ... 21	DO1 ... DO6	6 Digital outputs (Relays)	DO1: C=5.1
25 ... 30	U1 ... U4	4 Universal inputs / outputs with Q250	xx1: C=4.1 *)
31 ... 52	U5 ... U16	12 Universal inputs / outputs	xx5: C=1.1 *)
61, 62	CP+, CP-	PPS2 bus (for up to 5 QAX... room units)	
A		Ethernet socket	
C	HMI	RJ45 socket for PXM10	

*) Signal type when no application is loaded (wiring test):

U1...U4: xx = Y10S, U5...U16: xx = R1K



Caution!

- Observe the technical data for the relay outputs.
- Local installation regulations must be observed.

PXC22.1-E.D

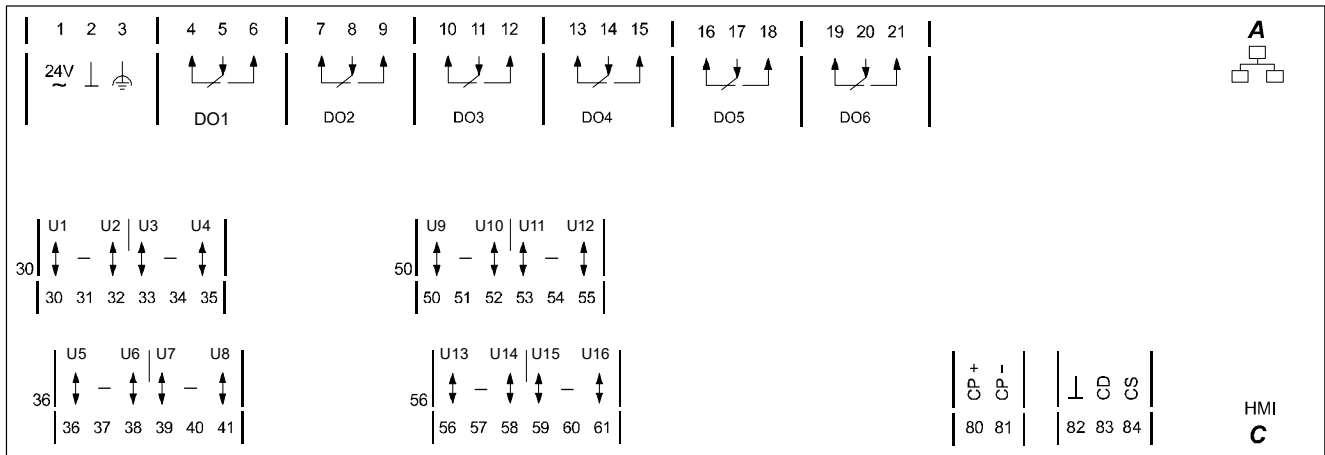

1, 2	24 V ~, ⊥	Operating voltage AC 24 V	
3	⊥	Functional earth	CFC IOAddr
4 ... 21	DO1 ... DO6	6 Digital outputs (Relays)	DO1: C=5.1
30 ... 38	U1 ... U6	6 Universal inputs / outputs with Q250	xx1: C=4.1 *)
39 ... 61	U7 ... U16	10 Universal inputs / outputs	xx7: C=1.1 *)
80, 81	CP+, CP-	PPS2 bus (for up to 5 QAX... room units)	
82 ... 84	⊥, CD, CS	Island bus: <i>Additionally, the system neutral conductor ⊥ of the island bus system must be connected to ⊥ (Terminal 82).</i>	
A		Ethernet socket	
C	HMI	RJ45 socket for PXM10	

PXC36.1-E.D

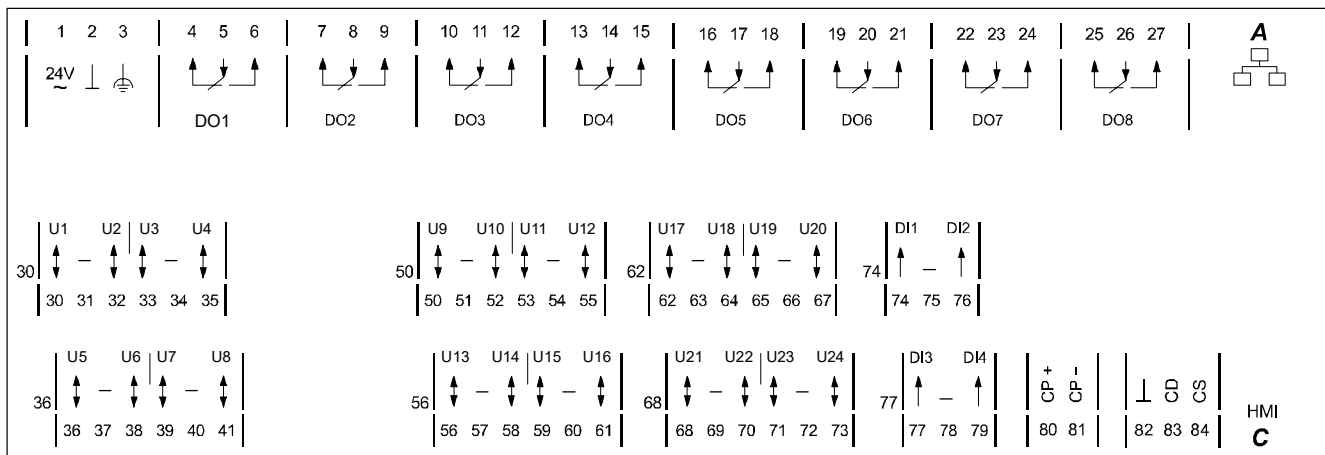

1, 2	24 V ~, ⊥	Operating voltage AC 24 V	
3	⊥	Functional earth	CFC IOAddr
4 ... 27	DO1 ... DO8	8 Digital outputs (Relays)	DO1: C=5.1
30 ... 38	U1 ... U6	6 Universal inputs / outputs with Q250	xx1: C=4.1 *)
39 ... 73	U7 ... U24	18 Universal inputs / outputs	xx7: C=1.1 *)
74 ... 79	DI1 ... DI4	4 Digital inputs	DI1: C=3.1
80, 81	CP+, CP-	PPS2 bus (for up to 5 QAX... room units)	
82 ... 84	⊥, CD, CS	Island bus: <i>Additionally, the system neutral conductor ⊥ of the island bus system must be connected to ⊥ (Terminal 82).</i>	
A		Ethernet socket	
C	HMI	RJ45 socket for PXM10	

*) Signal type when no application is loaded (wiring test):
 U1...U6: xx = Y10S, U7...U24: xx = R1K



Caution!

- **Observe the technical data for the relay outputs.**
- **Local installation regulations must be observed.**

Pin layout

Tool socket "HMI" (Ethernet)

Automation stations for **BACnet / IP**

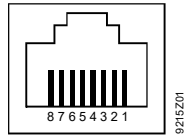

Pin Description

1. Unoccupied
2. Unoccupied
3. G0, GND
4. G/Plus

Pin Description

5. Unoccupied
6. Hot-wired to Pin 8
7. COM1/TxD
8. COM1/RxD

Tool socket "HMI" (LONWORKS)

Automation stations for **BACnet / LonTalk**

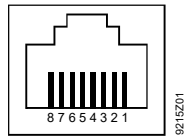

Pin Description

1. LONWORKS Data A (CLA)
2. LONWORKS Data B (CLB)
3. G0 / GND
4. G / Plus

Pin Description

5. Unoccupied
6. Hot-wired to Pin 8
7. COM1 / TxD
8. COM1 / RxD

Connecting island bus modules (For details, see TX-I/O Installation manual, CM110562)

Island bus supply

- The TX-I/O modules require a TXS1.12F10 power supply module.
- Additionally, the system neutral conductor \perp of the island bus system must be connected to \perp (terminal 82).

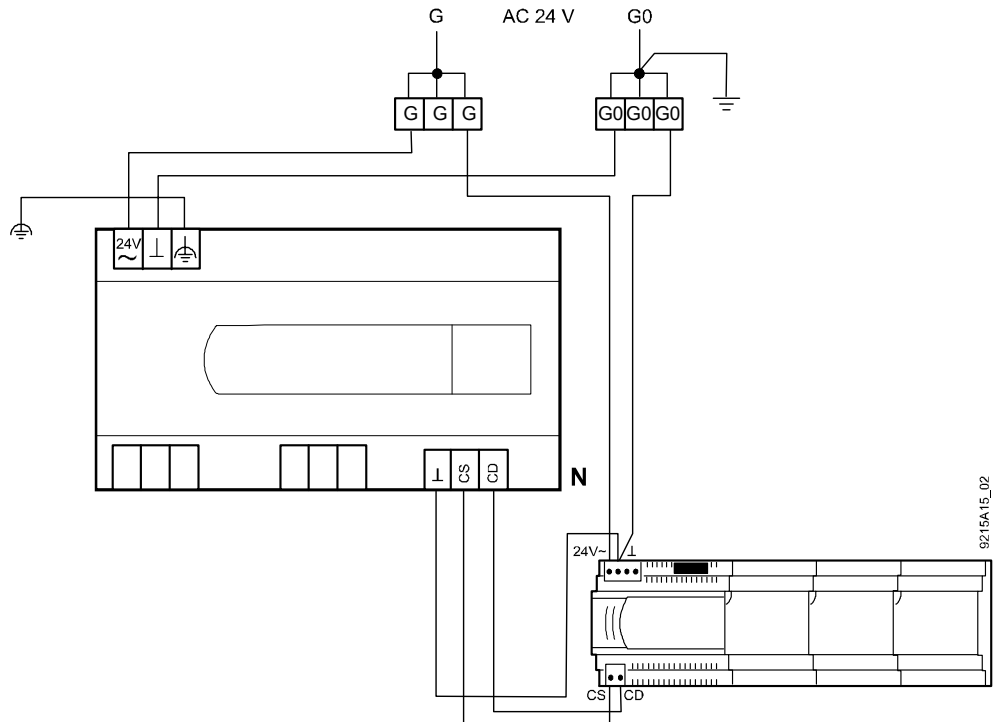

Grounding

- See TX-I/O Installation manual, CM110562

Connecting the field devices



Note!

In the automation stations described in this data sheet, system neutral (G0) and measuring ground (–) are NOT CONNECTED.

For active 4-wire field devices, this connection is made in the device.

For active 3-wire field devices, you have to make an additional connection:

- ① either on the terminals of the field device
- ② or between one of the (–) terminals of the automation station and G0 (in existing plants where there are only 3 conductors installed).

Field device supply voltage from system transformer

Counter inputs

Counter inputs faster than 1 Hz must be shielded if they are routed in the same trunking as analog inputs for more than 10 m.

Passive sensors
(e.g. QAM... , Ni 1000)
Active sensors
(e.g. QFM... , humidity)

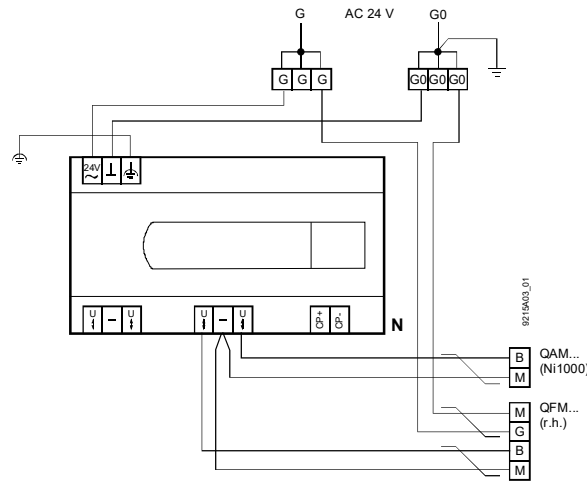

Magnetic valves
(e.g. M3P... + ZM
or MX...461...)

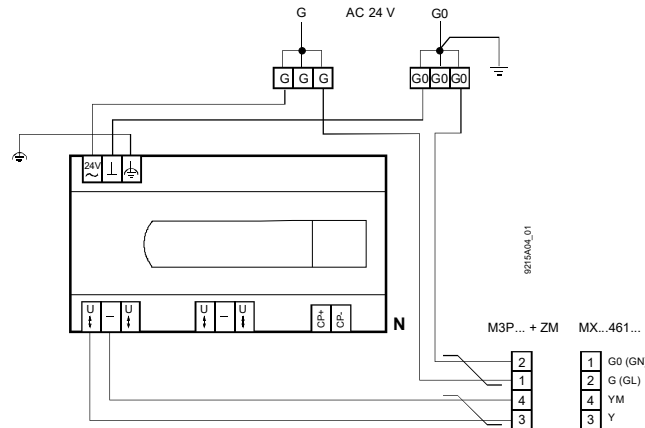

Motorized valves

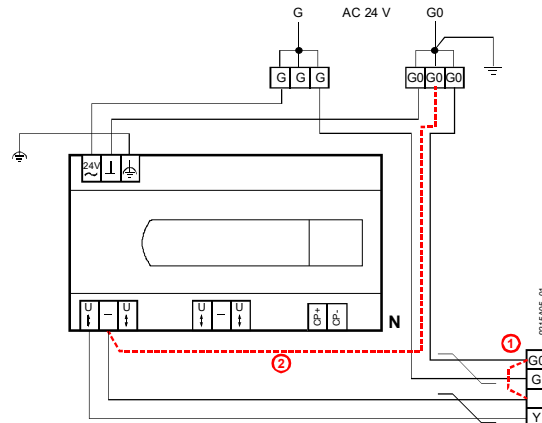

Damper actuators
(e.g. GBB161.1E)

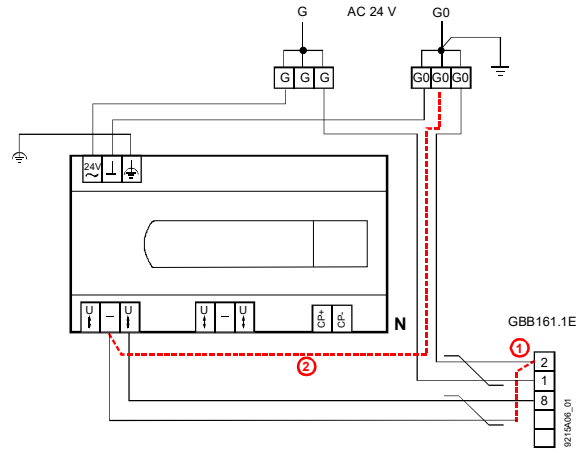

Field device supply from separate transformer

Magnetic valves
(e.g. M3P... + ZM
or MX...461...)

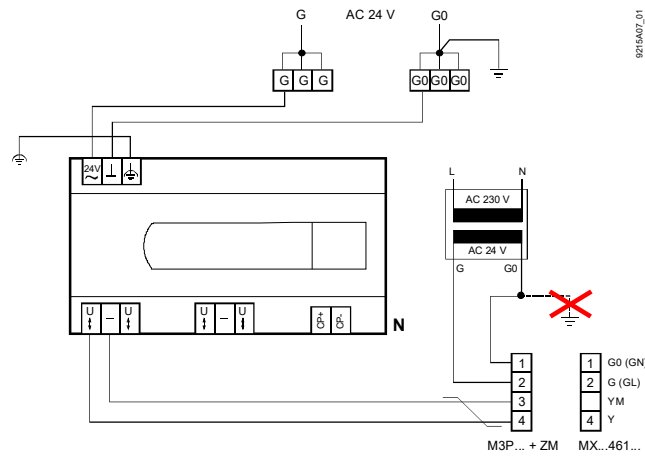

STOP Note!
Do NOT earth
the local
transformer

Connecting the room units

- N Automation station
- R... Max. 5 room units (parallel)
- PPS2
 - Twisted pair bus cable
 - Reversible polarity
 - Cable length, see "Technical data"

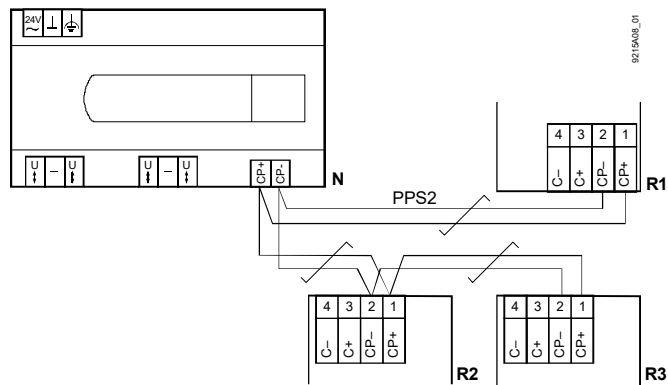

- Notes
- The room units are connected in parallel (max. five devices).
 - To distinguish between them, they must be addressed by use of jumpers (address plug on the printed circuit board). The factory-setting is Address 1.

Dimensions

(All dimensions in mm)

PXC12....D and PXC22....D

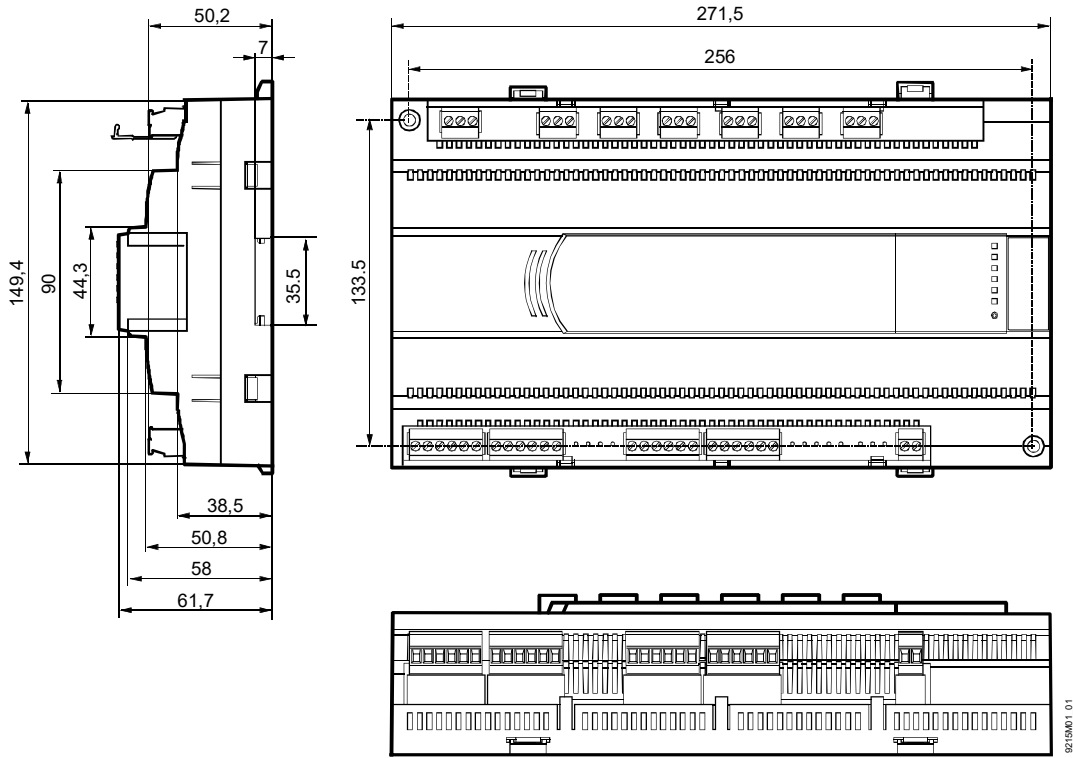

PXC22.1....D and PXC36.1....D

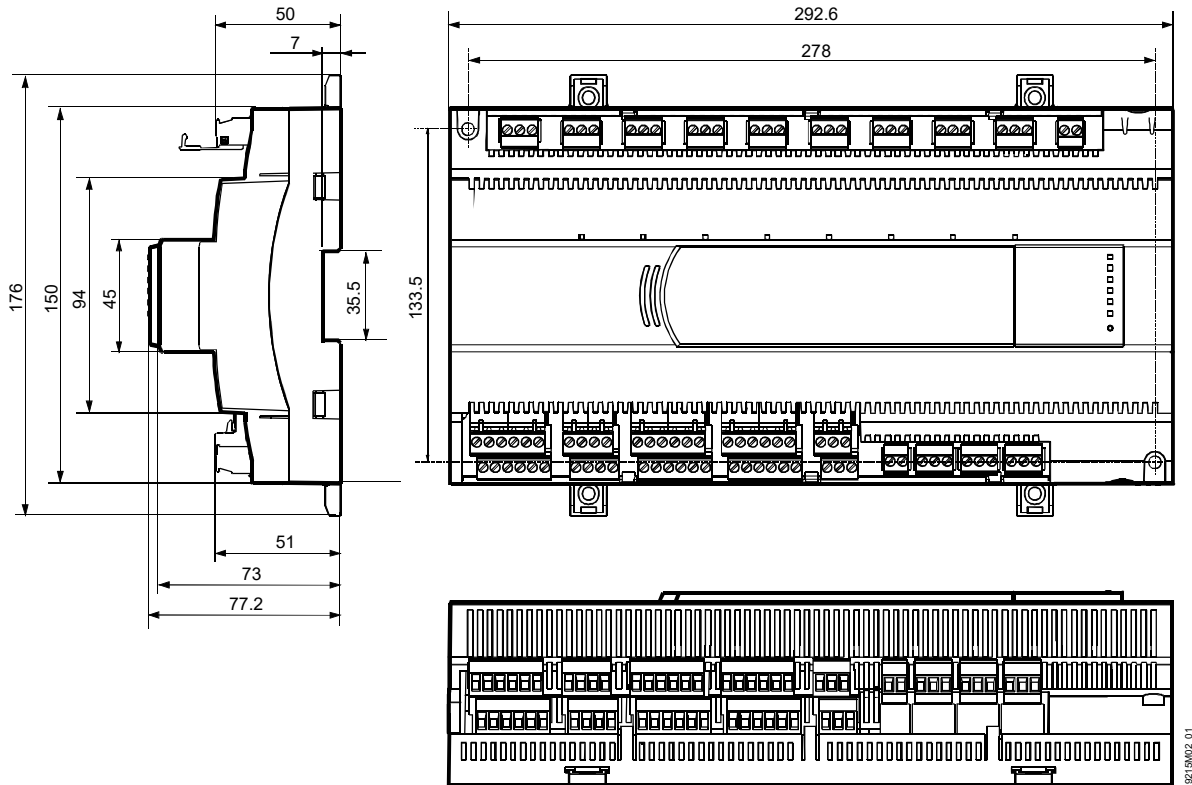

Disposal



The device is considered electrical and electronic equipment for disposal in terms of the applicable European Directive and may not be disposed of as domestic garbage.

- Dispose of the device through channels provided for this purpose.
- Comply with all local and currently applicable laws and regulations.
- Dispose of empty batteries in designated collection points.

Lithium batteries: May catch fire, explode or leak. Do not short circuit, charge, disassemble, dispose of in fire, heat above 100 °C, or expose to water.

Disposal: Seal battery terminals with tape.

Published by:
Siemens Switzerland Ltd.
Smart Infrastructure
Global Headquarters
Theilerstrasse 1a
6300 Zug
Switzerland
Tel. +41 41-724 24 24
www.siemens.com/buildingtechnologies

© Siemens Switzerland Ltd 2006
Delivery and technical specifications subject to change