



9760p01

Desigo™ Integral Migration

Automation station, compact series

PXC-NRUF

In existing Integral plants, you can replace compact automation units NRUE/A, NRUF/A and NRUT/A with the PXC NRUF automation station.

- Same housing.
 - Same periphery interface (plug compatible).
 - Existing periphery can be assumed without a change.
 - Use existing panel wiring.
- Compact, freely programmable automation station for HVAC and building services plants.
 - Native BACnet automation station with communications
 - BACnet via LonTalk
 - BACnet PTP (point-to-point)
 - Modem.
 - PPC processor allows for high performance and reliable operation
 - Comprehensive management and system functions (alarm management, schedulers, trends, remote management, access protection, etc.)
 - 64 physical inputs / outputs
 - Stand-alone application or for use with linked system or devices.
 - Supports the following operating elements:
 - Room units QAX...
 - Local / networkable operator units
 - System or WEB operation via system network.

Functions

Automation stations provide the infrastructure for recording and processing system and application-specification functions and are freely programmable. Comfortable management functions are integrated in addition to control functions, e.g.:

- Alarm management with alarm routing via the entire network. Standard, basis and expanded alarm management with checked secure transmission and automated transmission monitoring.
- Scheduler programs.
- Trend functions.
- Remote management function.
- Secured access to the entire network using individually defined user profiles and categories.

Programming language

The automation stations can be freely programmed (relying closely on CEN standard 1131) in D-MAP programming language. All function blocks, provided in libraries were graphically interconnected to plant operating programs.

Communication

The LONWORKS bus using internally standardized BACnet protocol is used for communications.

Both peer-to-peer communication to other automation stations as well as connection to operating units PXM... are supported.

Type summary

Device	Type	Data point mix			
		UI	DI	UO	DO
Automation station for 64 physical data points	PXC-NRUF	16	24	8	16

Accessories	Type designation
Connecting cable between operating unit PXM10 or PXM20 and the automation station.	PXA-C1
Adapter for firmware download.	PXA-C2

Operation

Various options exist to operating automation stations PXC-NRUF:

- **Room device QAX...** on the PPS2 interface. Up to a **maximum** of five room devices QAX... (without QAX5...) can be connected. Details on PPS2 communication are described in the Desigo Technical principles manual (Section "I/O blocks", subsection "PPS2 addressing").
- **Local operator unit PXM10 ***, is connected with cable PXA-C1.
- **Operator unit PXM20 ***, is connecting with cable PXA-C1, for local operation or for decentralized operation of an entire plant connected within a BACnet / LonTalk network.

Note *) Only one operator unit can be connected (PXM10 or PXM 20).

Web operation

The following web controllers support remote monitoring and operation using a standard Internet browser:

PXC...-E.D with PXA40-W1 or PXA40-W2.

Technical design

Inputs

Universal inputs (UI 1 ... 16) can be used for active sensor elements as well as potential-free contacts for signaling functions.

Digital inputs (DI 1 ... 8) allow non-potential-free reporting functions. They are **electrically isolated** from the system and from one another.

Digital inputs (DI 9 ... 16) allow reporting functions (**potential-free**).

Digital inputs (DI 17 ... 24) allow reporting and counting functions (**potential-free**).

Outputs

Universal outputs (UO 1 ... 8) can, on the one hand, control modulating actuators, on the other hand, they can be programmed for binary switching functions via the program structure.

Relay outputs (DO 1 ... 16) are designed for switching functions up to a maximum of AC/DC 42 V, 2 A.

Power supply

The device requires an external power supply AC/DC24V +/- 20%.
It must comply with SELV / PELV requirements!

The internal DC-DC converter supplies the internal processor system and inputs/outputs with controller voltage.

DC15V /200mA is also provided for active sensors (Integral periphery). This converter also establishes electrical isolation to the AC/DC24V power supply.

The device reset concept ensures defined conditions for field devices connected to the I/Os during power-up, power-down and undervoltage.

Overvoltage protection and startup protection protect the automation station against fluctuating power.

Design

The compact construction allows you to install the automation station in narrow spaces and is particularly well suited for compact panels or for plants using integrated panels.

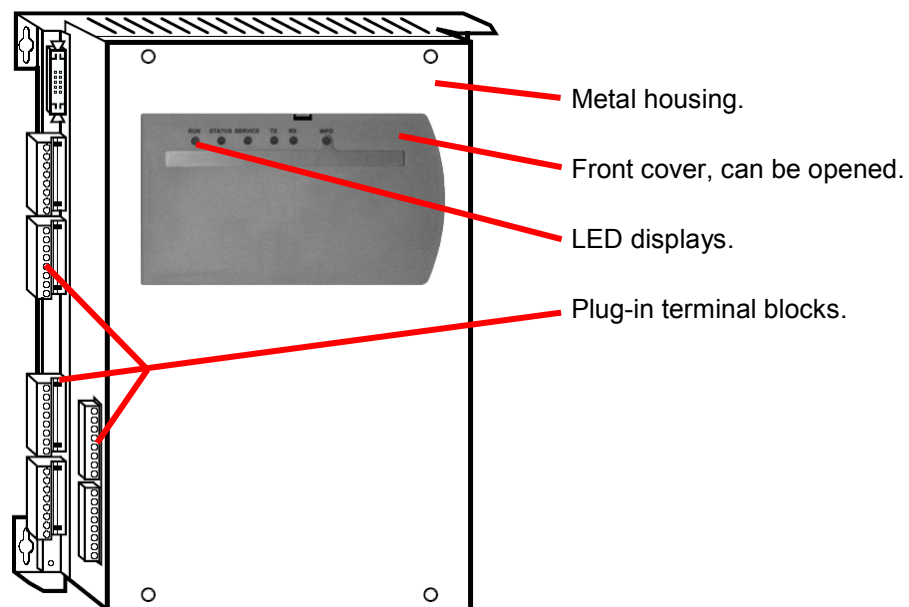

Terminal blocks

Terminal block can be plugged in to ease field device connection.
Existing Integral periphery can be plugged in at the same place as before.

Note Older Integral systems, where the terminal blocks do not fit:
Use the terminal blocks delivered with the PXC-NRUF.

LED displays

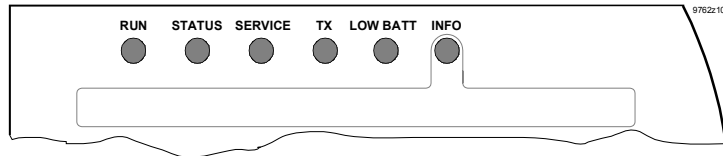

LED	Color	Activity	Function
RUN	Green	Continuously off Continuously on	No supply present. Supply present (LED controlled by SW).
STATUS	Red	Continuously off Continuously on Flashes quickly	Normal condition Hardware error recognized during self test or automation station in a state of "coma". There is no valid firmware present.
SERVICE	Red	Continuously off Flashing Flashes in wink command rhythm * Continuously on	LONWORKS node is configured. LONWORKS node is not configured. Physical identification of the automation upon receipt of the wink command. Neuron chip faulty or service button is pushed in.
TX	Yellow	Flashing	Data traffic on LONWORKS bus.
LOW BATT	Red	Continuously off Continuously on	Batteries OK (LED controlled by SW). Replace one or both batteries.
INFO	Red		Freely programmable.

* Wink command rhythm:

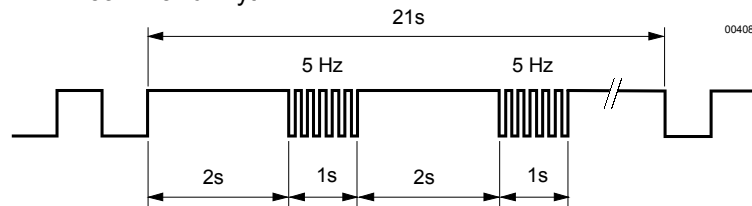

Service button

Identification of the automation station on the LONWORKS network: refer to "commissioning".

Disposal



The device is classified as waste electronic equipment in terms of the European Directive 2012/19/EU (WEEE) and should not be disposed of as unsorted municipal waste.

The relevant national legal rules are to be adhered to.

Regarding disposal, use the systems setup for collecting electronic waste.

Observe all local and applicable laws.

Mounting notes

The device can be attached directly to any surface with four screws, e.g. on the panel's base plate.

Plug-in screw terminal blocks are provided to connect field devices, power and bus wiring. The other interfaces are connected using the quick plug-in connections.

Do not open the device. All service functions are accessible via the lid.



The front cover may only be opened by instructed service staff!

Comply with country-specific safety regulations and corresponding safety provisions to prevent personal injury or damage to property.

Download plant operating programs

The tool Desigo Xworks plus is used to download the plant operating program via the network (BACnet/LonTalk).

Set parameters and configurations

Use Desigo Xworks plus to set control parameters and configuration data. You can also edit data visible in the network using the PXM20 operator unit.

Wiring tests

Field devices and wiring can be tested with the operating unit PXM20 as soon as power is connected. There for loading the plant operating programs is not needed.

Network connections

Desigo Xworks plus configures network addresses. For unique identification in the network (BACnet/LonTalk), press the **service button** or send a wink command to the corresponding automation station (service LED flashes).

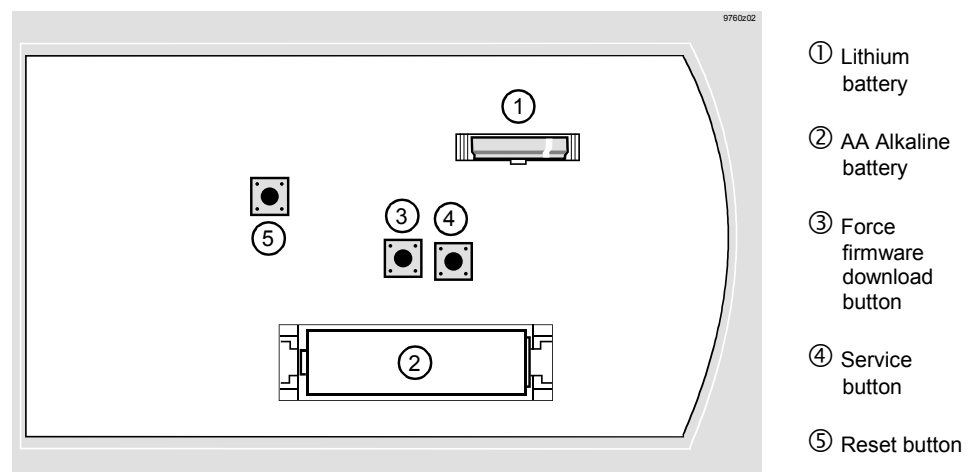

Firmware download

The current D-MAP program is deleted from FLASH when the **Firmware Download button** is pressed during restart (reset).

The automation station waits a moment for the signal to activate the FWLoaders and then starts the automation station.

Restart

Press the **reset button** to force a restart.

Battery effective life

Database information is stored in **SDRAM** memory, that is supported by a battery (**alkaline type AA**). This avoids costly reloads of programs and databases following a longer power outage (up to ca. 1 month).

The unused effective life for alkaline batteries is at least four years.

The remaining life under load is just a few days following a "battery low" event.

The **real time clock** is supported by a **lithium battery** with an effective life of at least 10 years.

The LOW BATT LED is lit for insufficient load of one of the two batteries and the automation station automatically sends a system event and a device alarm.

Replace battery

Open the blue lid to replace the batteries. You can take out the batteries for as long as you want, when the unit is powered.



Caution!

To prevent damage to the hardware from electrostatic discharge (ESD), use a grounded wristband to change batteries.

Firmware upgrades

Firmware and operating system are stored in non-volatile manner (on Flash ROM). It is easy to update the Flash ROM memory for the plant when new firmware versions become available.

Technical data

General device data	Operating voltage	AC/DC 24 V ± 20 % (SELV / PELV)
	Frequency	0 / 50/60 Hz.
	Power consumption	max. 26 VA.
	Internal fuse	thermal, automated reset.
Functional data	Processor	Motorola PPC (MPC 885).
	Storage location FLASH	16 MB.
	RAM	64 MB.
	Data backup during power outage	
	Applications / Parameters (FLASH)	> 10 years.
	Runtime data (buffered by AA alkaline, can be replaced on the plant)	Unused: 4 years. Typically 1 month in case of supply failure (grid or AC 24 V)
	Realtime clock (buffered by Lithium battery, can be replaced on the plant).	10 years.
	Precision category	0.5.
Sampling cycle	max. 1 second.	
Universal inputs UI 1 ... 16	Can be configured in software	
	A/D resolution (analog in)	16 bit.
	Measured value inputs	
	Area	0 ... 11.0 V.
	Input resistance	100 kΩ against –.
	Sensor inputs	
	Temperature sensor	
	LG-Ni 1000, Ni 1000, Pt 1000, T1	Measuring range – 50 ... 150 °C
	Sensor electricity (pulsed)	approx. 1.5 mA (peak).
	Resolution	0.2 K.
	Meas. error at 25 °C (Ni 1000, Pt 1000)	max. 0.2 K (excluding wire + sensor).
	Measuring error at 25 °C (T1)	max. 1.0 K (excluding wire + sensor).
	Signal input	
	Contact voltage	DC 20 ... 25 V.
Contact electricity (pulsed)	7 mA (peak).	
Contact resistance	Max. 200 Ω (closed).	
Insulation resistance	Min. 50 kΩ (open).	
Digital inputs DI 1 ... 8 Not potential free.	Electrically isolated	From system and from one another
	Area.	Low < AC/DC 6V. High = AC/DC 15.. 42 V ± 10%.
	Interior resistance.	Ri = 4kΩ.
Digital inputs DI 9 ... 16	Contact voltage.	DC 20 ... 25 V.
	Contact current (continuous).	7 mA.
	Contact resistance.	Max. 200 Ω (closed).
	Insulation resistance.	Min. 50 kΩ (open).

Digital inputs DI 17 ... 24 with counting function	As DI 9 ... 16; additionally counting function: Counter frequency (symmetrical) Max. 25 Hz. Min. closing/opening time incl. bouncing 20 ms Max. bounce time 10 ms Counter memory 8 Bit (0...255 → max. cycle time 10 s at 25 Hz) <i>Counter inputs must be shielded, if they count faster than 1 Hz and are routed with analog inputs in the same trunking for more than 10 m.</i>
Universal outputs UO 1 ... 8	Can be configured in software D/A resolution (analog out) 10 bit. Modulating Output voltage range 0 ... 11.0 V. Output current Max. 1.5 mA source, max. 1.5 mA reduction. Digital Output voltage 0 / 10V Output current 1.5 mA
⚠ Relay outputs DO 1 ... 16	Number of switching outputs 16 (changeover contact) External fuse protection for incoming cable – Slow blow fusible link Max. 10 A – Circuit breaker Max. 13 A Circuit breaker tripping characteristic Type B, C or D to EN 60898 Contact data AC/DC switching voltage max. AC 42 V / DC 42 V min. AC / DC 12 V AC current rating Max. 4 A resistive, 3 A inductive Min. 4 mA at AC 42 V Min. 10 mA at AC 12 V Current on make (AC) Max. 10 A (1 s) DC current rating Max. 2 A resistive at DC 42 V Min. 10 mA resistive at DC 12V Response / dropout time 7 ms / 3 ms typical Service life of contact for AC 42 V (guide values) With 0.1 A resistive 1 x 10 ⁷ switching operations With 0.5 A resistive 3 x 10 ⁶ switching operations With 4.0 A resistive (N/O) 2 x 10 ⁵ switching operations Reduction factor with inductive load 0.85 (cos phi = 0.6) Insulation resistance: Basic insulation AC 2500 V, to EN 60730-1 between relay outputs and system elec- tronics
Interface room units.	Interface type PPS2. Feed category 4 Baud rate PPS2 4.8 kbps.
Interface LONWORKS bus. (screw terminal).	LONWORKS FTT transceiver Network TP/FT-10. Baud rate 78 kbps. Protocol BACnet.
Local communication (HMI, RJ45).	PXM10 (RS-232). PXM20 (BACnet/LonTalk) • One operator unit PXM10 or PXM 20 can be connected per automation station. • LONWORKS bus instead of the RS 485 bus used in Integral plants.

Plug-in screw terminals Simply cable lengths, and cable types	Power supply and signals	Solid or stranded wire 0.25...2.5 mm ² or 2 x 1.5 mm ² .
	LonWorks bus	Solid or stranded wire 2 x 1.0 mm ² .
	Universal inputs UI 1...16	Max. 100m with A = 1 mm ² .
	Digital inputs DI 1...24	Max. 100 m with diameter 0.6 mm.
	Universal outputs UO 1...8	Max. 100m with A = 1.5 mm ² .
	Relay outputs DO 1...16	Depends on load and local regulations.
Classification to EN 60730	Interface room units PPS2	Max. 125 m with A = 1.0 mm ² .
	Cable type	2-core, twisted pairs, unshielded.
	Capacity	max. 56 nF/km.
	Interface cable LONWORKS bus	See installation guide PX, CA110396.
	Cable type	CAT5.
Housing protection.	Connecting cable PXM10	Max. 3 m.
	Automatic action	Type 1
	Pollution degree	2
	Protection class	III (Device also suitable for use in protection class II equipment)
Ambient conditions	Protection as per EN 60529	IP 20.
	Operation	Class 3K5 as per IEC 60721.
	Temperature	0 ... 50 °C.
Standards, directives and approvals.	Humidity	5..95 % r.h. (no condensation)
	Transportation	Class 2K3 per IEC 60721.
	Temperature	- 25 ... 70 °C.
	Humidity	5 ... 95 % r.h. (no condensation)
	Product standard	EN 60730-1
Environmental compatibility	Electromagnetic compatibility (Applications)	For use in residential, commerce, light-industrial and industrial environments
	EU conformity (CE)	CM2T9760xx *)
	RCM-conformity (EMC)	CM1T9222en_C1 *)
	EAC conformity	Eurasia conformity
Dimensions	Product environmental declaration (contains data on RoHS compliance, materials composition, packaging, environmental benefit, disposal)	CM2E9760 *)
	Weight	
	Refer to dimensions	
	<i>Excl. packaging</i>	<i>packaged.</i>
	2.960 kg	3.130 kg

*) The documents can be downloaded from <http://siemens.com/bt/download>.

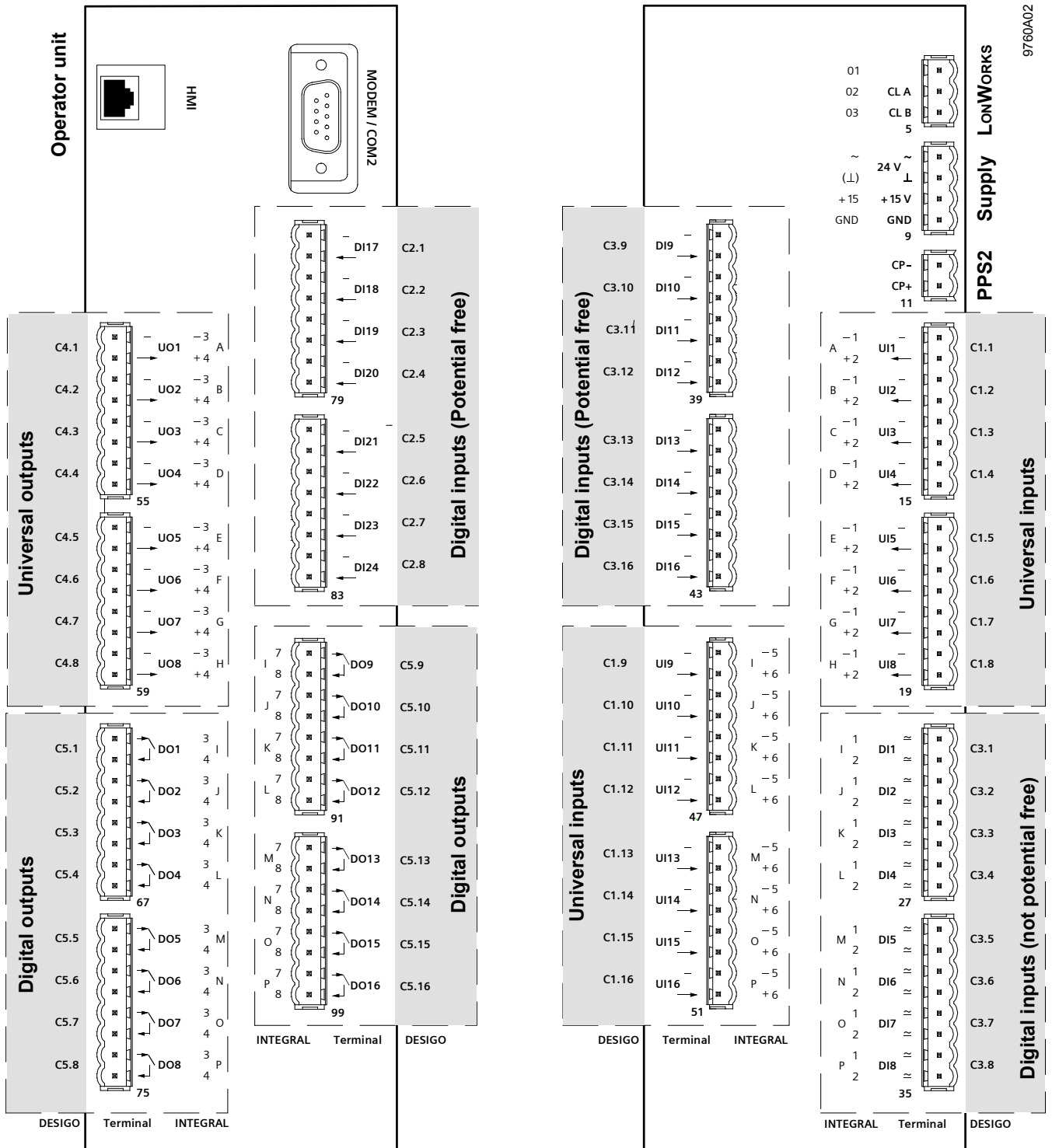

9760A02



Caution!

- Observe the technical data for the relay outputs.
- Local installation regulations must be observed.

Pin occupancy

"HMI" socket (LONWORKS)

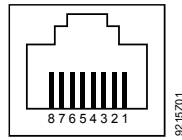

Pin description.

1. LONWORKS Data A (CLA).
2. LONWORKS Data B (CLB).
3. GND.
4. Plus 24V.

Pin description.

5. Unoccupied.
6. Connected to 8.
7. COM1 / TxD.
8. COM1 / RxD.

Interface Modem / COM2

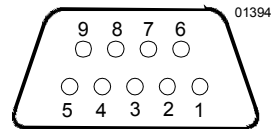

Pin

Abbr.

Description

1	DCD	data carrier detect
2	RXD	received data
3	TXD	transmit data
4	DTR	data terminal ready
5	GND	signal ground
6	DSR	data set ready
7	RTS	request to send
8	CTS	clear to send
9	NC	not connected



Note!

This is a device using the 4-wire principle. System ground (G0) and measuring ground (– or GND) are electrically isolated.

For active field devices using **4-wire** technology, this connection is in the field device.

For active field devices using **3-wire** technology, the connection must be established separately:

- ① Either at the terminal on the field device.
- ② Or in existing plants, using only 3 wires: at the automation station between one of the terminals (–) and G0.

A) Field device supply of system transformer

Compulsory specification for transformer

Type Safety isolating transformer AC 230 V/AC 24 V to EN 61 558
 Fusing AC 24 V **Max. 10A slow-blow** (Extra-low voltage fuse)
Max. 13 A circuit breaker

Counter inputs

Counter inputs must be shielded, if they count faster than 1 Hz and are laid with more than 10 meters using analog inputs in the same cable duct.

Passive sensor
 (e.g. QAM... , Ni 1000)

Active sensor
 (e.g. QFM... , humidity)

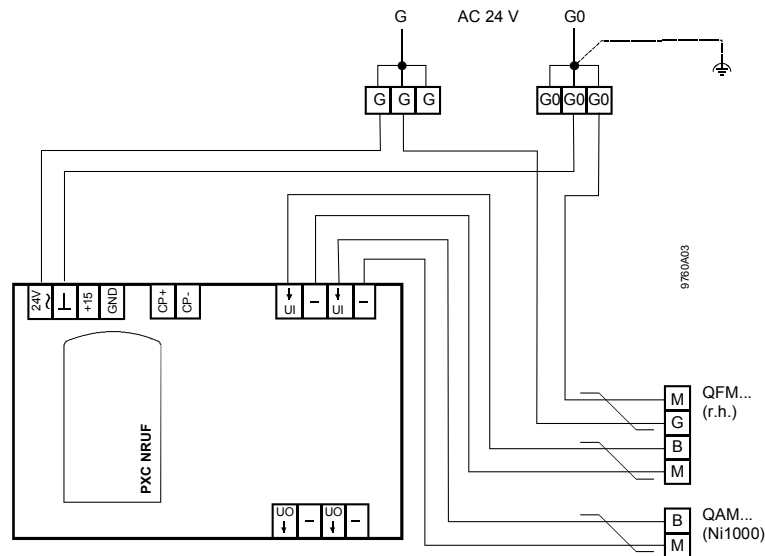

Magnetic valves
 (e.g. M3P... + ZM or MX...461...).

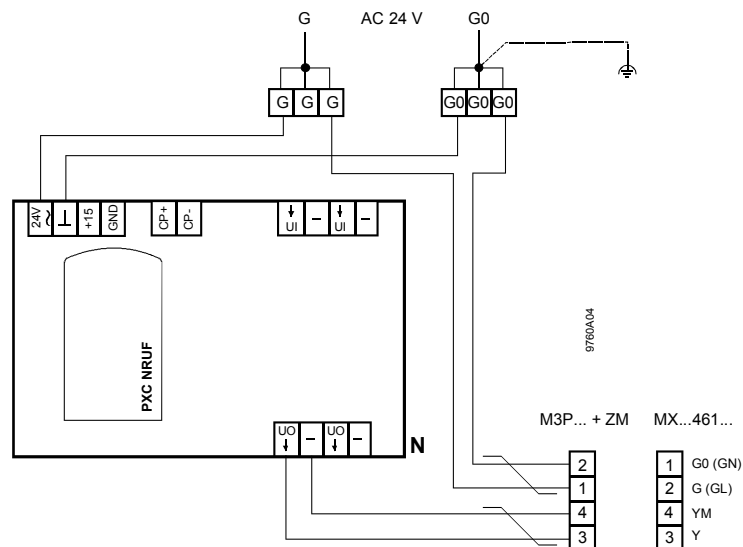

Motor valves

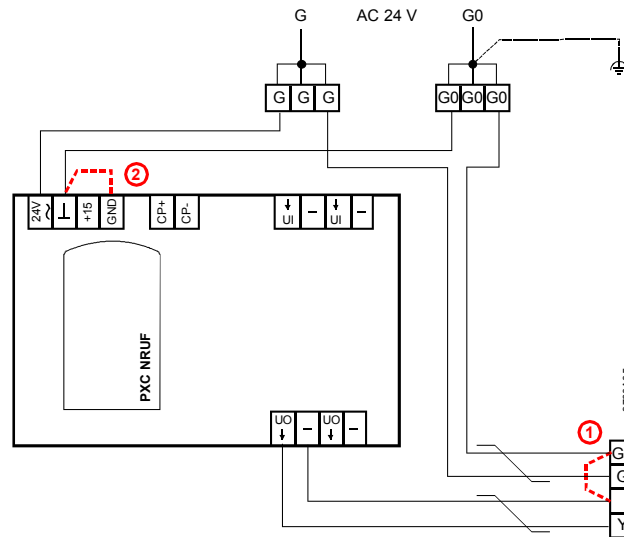

Damper actuators (e.g. GBB161.1E).

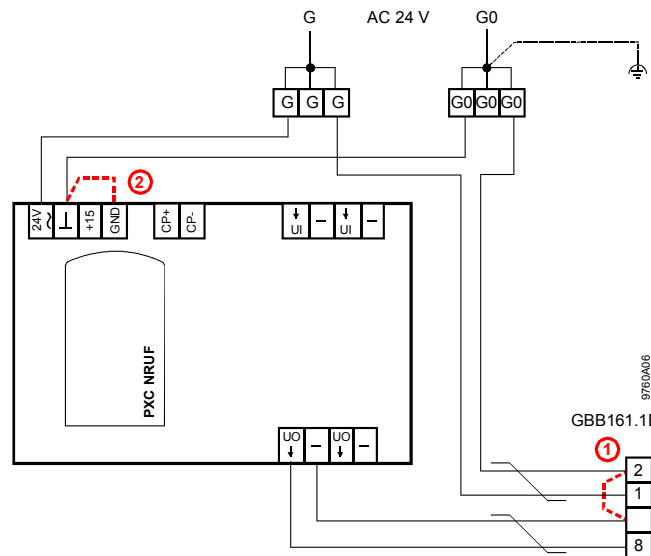

B) Field device supply of separate transformers

Magnetic valves (e.g. M3P... + ZM or MX...461...).

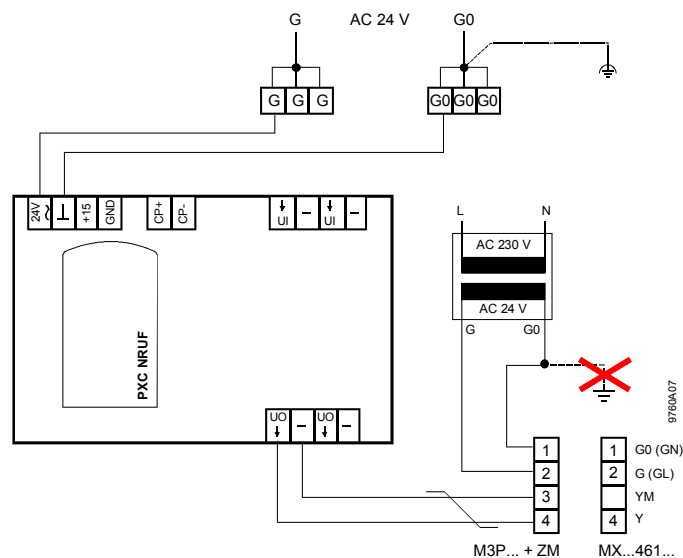

STOP Note!
Do NOT
ground
separate
transformer

C) Connect room units

N Automation Station.

R... Max. 5 room units (parallel).

- PPS2
- Twisted pair bus cable.
 - Interchangeable polarity
 - Wire length, refer to "Technical data".

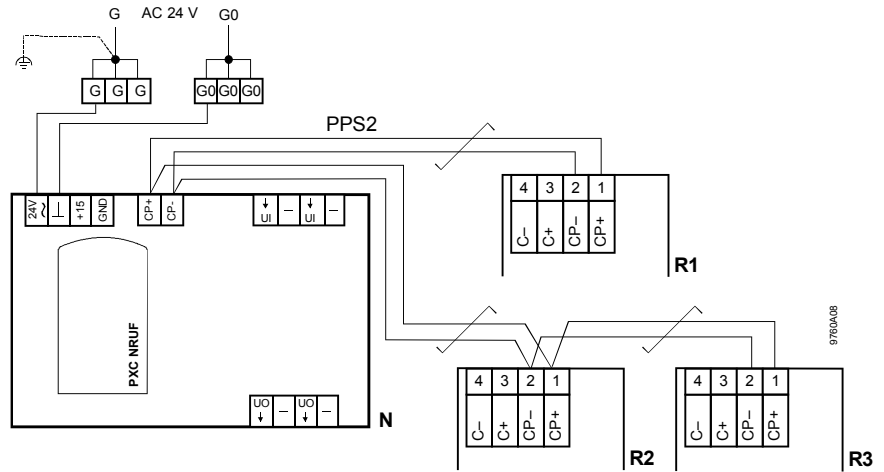

- Notes
- Room units are connected in parallel (maximal 5).
 - Must be addressed using a jumper to distinguish (address plug on the circuit board). The address factory set to 1.

Dimensions

All dimensions in mm

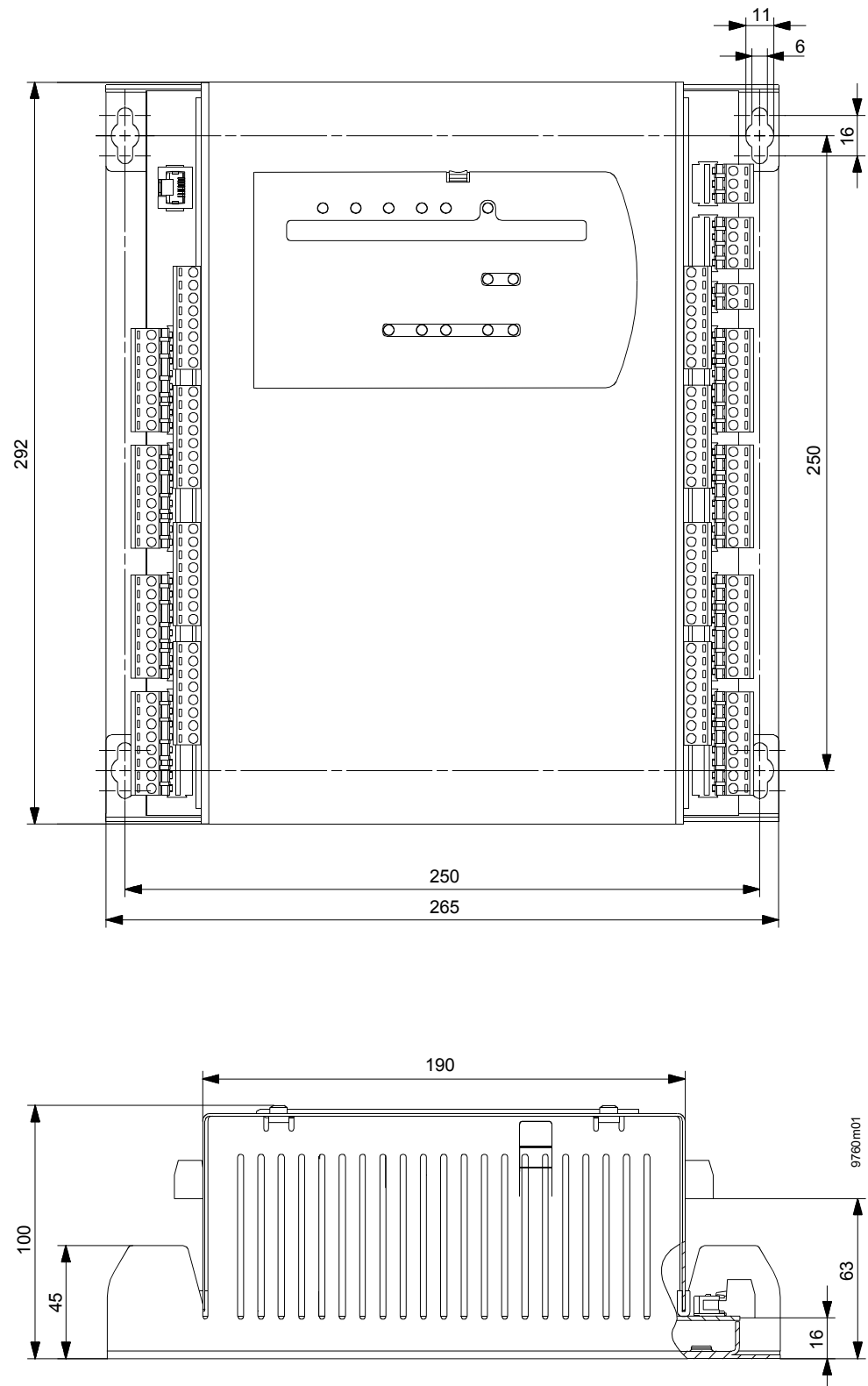

Published by:
Siemens Switzerland Ltd.
Building Technologies Division
International Headquarters
Gubelstrasse 22
6301 Zug
Switzerland
Tel. +41 41-724 24 24
www.siemens.com/buildingtechnologies

© Siemens Switzerland Ltd 2008
Delivery and technical specifications subject to change