



## Web Server

For Synco™, Synco™ living

## OZW772... V6.0

**Web Server OZW772... allows for remote plant control and monitoring via the web and Smartphone App.**

**Four versions of the Web Server OZW772... are available: To connect 1, 4, 16, or 250 Synco devices from product ranges Synco 700, room controllers RXB/RXL, RDG/RDF/RDU room thermostats, and the QAX9... Synco living central apartment units.**

- Operate web browser via PC/laptop or Smartphone.
- Operation via Smartphone App (iPhone and Android)
- Operation via Internet portal with auxiliary functions
- Operation and monitoring of KNX S-Mode devices (Lighting, blinds, energy and volume meters, etc.)
- Visualize the plants in the web browser based on standard plant diagrams and customized plant web pages.
- Connections: USB and Ethernet.
- Display fault messages in the web browser.
- Send fault messages to a maximum of 4 e-mail recipients.
- Periodic sending of system reports to a maximum of 4 e-mail recipients.
- Consumption data Recording, display, and sending to 2 e-mail recipients
- Create trends, Trend graphs and send trend data to 2 e-mail recipients

- **Function "Energy indicator" for monitoring data points for energy-technical limit values, so-called "Green limits", and sending them to 2 e-mail recipients**
- **Web services for external applications via Web API (Web Application Programming Interface)**
- **Encrypted with https and TLS for e-mails.**
- **ACS790 functionality.**

## Use

---

### Building

- Apartments in single and multi-family homes.
- Office and administrative buildings, residential housing.
- Schools, gymnasiums, leisure facilities, hotels.
- Municipal buildings, smaller industrial buildings.

### Owners/operators

- End customers, HVAC and electrical installers.
- Real estate companies, real estate management companies.
- Building maintenance companies, energy and facility management.

## Functions

---

### Commissioning

Commissioning using a PC/laptop via web browser or ACS. ETS (Version 4 or 5) is used to configure KNX S-Mode components.

### Web operation

- Remote operation and monitoring and devices on one KNX network with web browser on PC/laptop and smartphone.
- Access via Internet portal or direct connection
- Simultaneously supports multiple users.
- User accounts for web operation (user groups, operating language).
- Set up visualized operation based on standard plant diagrams (loaded via HVAC Integrated Tool, HIT) or customized plant web pages.

### Access via portal

Siemens offers with the Climatix IC / Synco IC Internet portal simple and secure access to web serves (available as of Web Server version 5.2).

### Benefits

- Simple and fast set up of access via the Internet – neither a fixed IP address, nor forwarding of a dynamic IP address, nor port forwarding (NAT/PAT) is required
- The portal provides additional functions:
  - Manage one or multiple plants
  - Central user management
  - Display of plant overview, state of Energy indicators, and alarms
  - Plant functional scope can be set for various plant roles
  - Logging fault messages as common faults
  - Send alarm notifications per e-mail
  - Secured communications through encryption (https)

### Access without portal (direct connection)

The Web Server can be accessed directly via the Internet (without using the portal). A fixed IP address to the Web Server is required or a dynamic IP address with forwarding via a dynamic DNS server. In addition, the port forwarding must be configured on the router.

A direct connection in parallel to the portal is also possible.

## Web interface

The Web Server interface is the same using the portal or via a direct connection. The portal has, however, additional functions and available settings.

## User interface portal

The screenshot shows the Siemens Web Server user interface portal. The top navigation bar includes 'Home', 'Operating', 'Application sets', and 'Administration'. The user is logged in as 'name@example.com'. The main content area displays the 'Ethernet' settings for 'Datapoint' and 'UPnP localization'.

Datapoint	Value
DHCP client	On
IP address	192.168.1.35
Subnet mask	255.255.255.0
Default gateway	192.168.1.1
Preferred DNS server	80.58.61.250
Alternate DNS server	80.58.61.254
Set when DHCP client off	
IP address	192.168.2.10
Subnet mask	255.255.255.0
Default gateway	192.168.2.1
Preferred DNS server	192.168.2.1
Alternate DNS server	
UPnP localization	Ethernet
Physical address	00:a0:03:fd:90:2d
Portal connection	On

Click the symbol to open the Web Server user interface under a new tab and is then the same as the view under a direct connection.

The portal symbol and e-mail address is displayed in place of the user symbol and user name.

## User interface Web Server (direct connection)

The screenshot shows the Siemens Web Server user interface via direct connection. The top navigation bar includes 'Home', 'Faults', 'File transfer', 'User accounts', and 'Device web pages'. The user is logged in as 'Administrator [Logout]'. The main content area displays the 'Ethernet' settings for 'Datapoint' and 'UPnP localization'.

Datapoint	Value
DHCP client	On
IP address	192.168.1.35
Subnet mask	255.255.255.0
Default gateway	192.168.1.1
Preferred DNS server	80.58.61.250
Alternate DNS server	80.58.61.254
Set when DHCP client off	
IP address	192.168.2.10
Subnet mask	255.255.255.0
Default gateway	192.168.2.1
Preferred DNS server	192.168.2.1
Alternate DNS server	
UPnP localization	Ethernet
Physical address	00:a0:03:fd:90:2d
Portal connection	On

## Primary navigation

Primary navigation offers the following functions:

Home	Menu-based plant and device operation.
Energy indicator	Display and operating of "Energy indicator" data points (Displayed only if a controller is connected with an Energy indicator)
Faults	Display system faults.
File transfer	Create and manage trend functions Download consumption data and message history, upload documents, logos, and system definitions
User accounts	User administration.
Device web pages	Create device list and operating pages.

## Secondary navigation

The secondary navigation (menu tree) allows users to select devices and operating pages. As of OZW version 5.0, the KNX pages defined in ETS as displayed here as well.

## Display

The display range displays content corresponding to the selected primary and secondary navigation.

## Plant state



The display indicates no fault or the most serious plant fault depending on plant state.

## Faults

### Fault sources

The Web Server recognizes failures and fault signals from KNX devices contained in the device list. Own faults also are recognized.

### Fault display, fault acknowledgement

The LED signals a fault on the Web Server . LED blinks to indicate that a fault is unacknowledged.  The LED continues to be lit for as long as the fault is pending after the fault is acknowledged with the  button via web operation or ACS. (See page 10 for LED displays and operating buttons).

### Fault status message

Fault status messages can be sent as an e-mail to as many as 4 e-mail recipients and/or via a service provider to SMS recipients. You can set the fault priority for each e-mail recipient (urgent/all). Each receiver has a "Time switch with calendar" to program three sending times per day and holidays/special days.

### Common fault

On the Climatix IC/Synco IC Internet portal, faults are logged as common faults. The portal sends alarm notifications to the defined e-mail addresses in the event of a common fault.

## System report

### System messages

The Web Server generates system reports and periodically sends the system operating state to e-mail recipients. Messages are sent as per the set time (hh:mm), message cycle interval (1...255 days), and priority (urgent/non-urgent).

### Connection test

Press the  button on the Web Server to send a system report to all defined e-mail recipients regardless of fault priority.

## History

The last 500 fault events, fault messages and system reports are entered in the Web Server's circular message buffer. The event or history data can be read via web browser.

## Time

The Web Server has a system clock with adjustable time zone and daylight saving/standard time changeover. As clock time master, it can send the set system time (date and time) to KNX devices (clock time slave).

## Updates

We differentiate between the following:

- System definition updates to integrate device descriptions of new devices in the Web Server.
- Firmware updates to update the Web Server to the latest firmware version. Firmware updates may also contain new device descriptions (system definitions).

A system definition update requires one simple action via the web browser. No operator actions on the Web Server are required to update the firmware. Procedures are communicated when a firmware update is issued.

## ACS790

The Web Server is compatible with the service and operating software ACS790 version 8.00 and higher.

No ACS790 functionality is available when accessing via the portal.

## Visualize plants

Web Server OZW772... allows for visualizing technical equipment (HVAC, electrical, energy values) in buildings via plant web pages. For example, a plant web page can be set up visualizing a plant with data points (max. 100 data points per plant web page) on a floor plan.

In the event of a fault, users can quickly access the impacted locations.

Double-click writable parameters to open a dialog box and edit the value.

Example  
Plant web pages for  
ventilation plant

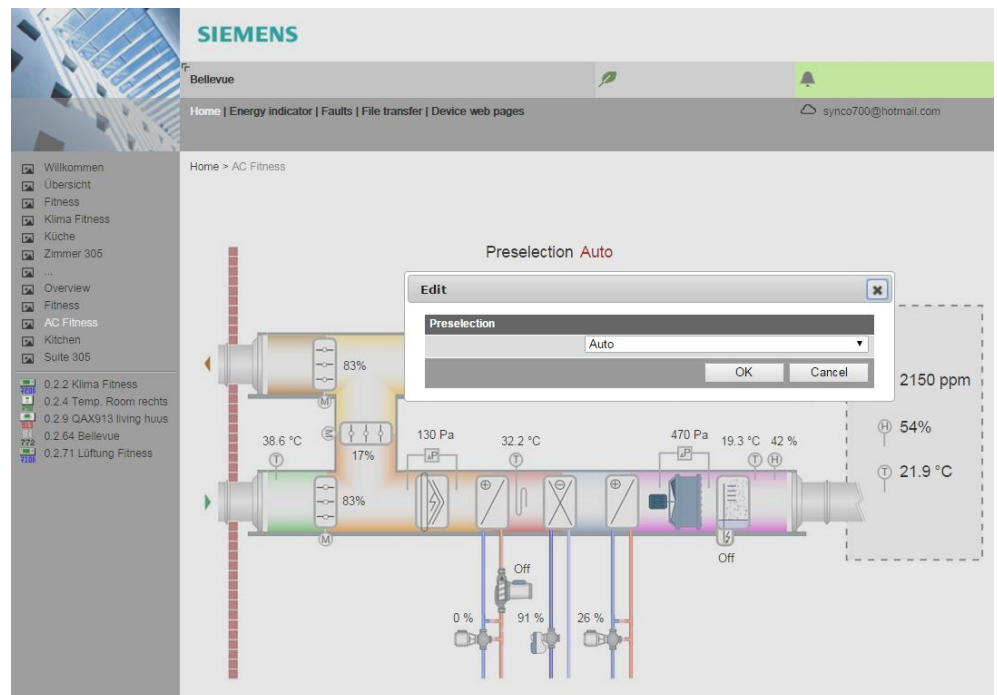

Example  
Plant web pages for  
HVAC and lighting, blinds

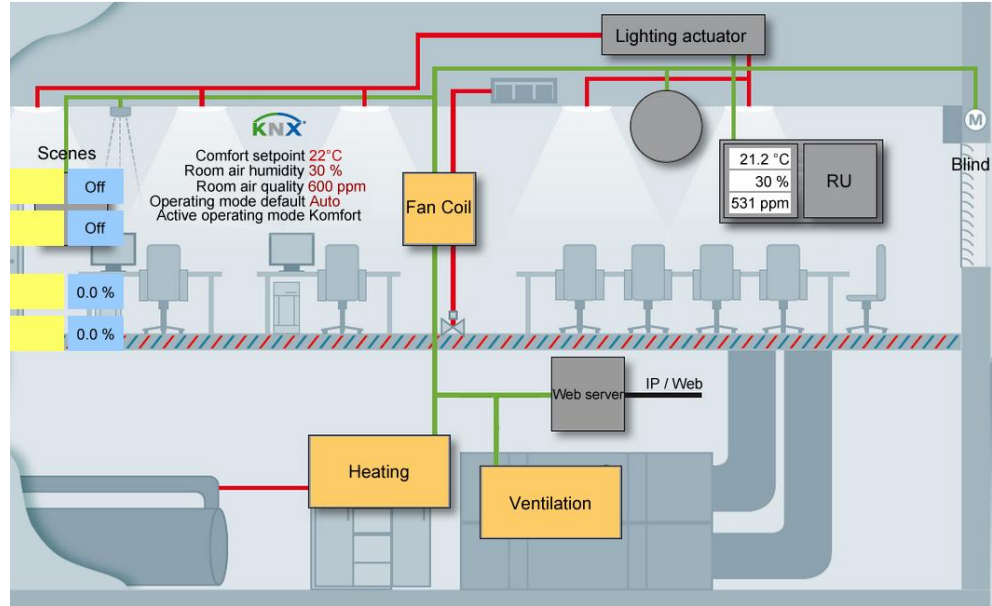

Download  
plant diagrams

You can download web-capable plant diagrams from the HIT online platform for standard applications on Synco 700 devices, room controllers RXB/ RXL, and room thermostats RDG/RDF/RDU.

Create own plant web  
pages

You can freely design plant web pages. As a hybrid form, you can also modify and extend downloaded plant diagrams.

Web page elements

Users can also embed additional data in a plant diagram such as energy values (version 5.0) or links to plant, function and maintenance descriptions or data sheets. Moreover, users can integrate external links allowing, for example, for direct browsing multiple plants. Users can embed current webcam images in a plant diagram.

**KNX S-Mode**

Integration of KNX S-Mode data points permits central control of heating, ventilation, air conditioning, and electrical installations. Data points recording by OZW can be used, for example, for trending, to depict the plant diagram or reused for thermal or electrical energy consumption.

Number of S-Mode data  
points

Version OZW772.01 supports 7 standard data points for system time and alarm info functions. For version OZW772.04/16/250, the following of data points can also be integrated:

Data point sub-types	No.
1 bit value	100
2 bit switching controlled	5
1 byte value	40
1 byte scene	5
2 byte value	40
4 byte value display	40
Amount	230

KNX interfaces

The Web Server OZW772... also assumes the KNX/IP interface, (KNXnet/IP), using its Ethernet interface. Separate devices to connect the ETS to the KNX bus via Ethernet are no longer necessary.

## Group monitoring

Web Server OZW772... supports the ETS diagnostic function "Group Monitoring" as of version 6.0.

## Trend function

The trend function can be defined directly in the Web Server OZW772... as of version 5.0.

Any number of data points for connected devices can be logged at a selectable sample rate and queried using the trend function.

Data points for devices integrated via KNX S-Mode are also available for the trend function.

## Trend channels

5 trend channels are available: Each trend channel can include up to 100 data points. The trend channel can be labeled using a plain text name.

## Sample rate

The sample rate can be created individually for each trend channel. Sample rates from 1 second to 25 hours are available.

The shortest possible sample rate over all 5 trend channels is 1 data point per second.

## Trend period

Memory determines the possible trend period of a trend channel. The trend period varies with the number of selected data points and their sample rate.

Examples for various trend channels:

Interval	Data points	Trend period	
		Channel 1	Channel 2...5
1 sec	1	14 days	1.8 days
5 sec	5	30 days	4.3 days
1 min	10	210 days	30 days
15 min	100	371 days	53 days

Memory that is 7 times greater is available in trend channel 1 for long-term trending with a lot of data points, or short sample intervals.

## Synchronization

Trends are synchronized to simplify the evaluation of trend data. The various query intervals for the trends are set up on one interval grid.

## Operation

A web browser or the ACS tool creates and manages trend functions.

The screenshot displays the Siemens OZW772.16 web interface. The top navigation bar includes links for Home, Energy indicator, Faults, File transfer, User accounts, and Device web pages. A user menu shows Administrator [Logout]. The main content area features a table of trend data:

Name	State	Query interval	Circular logging	Bus load	Action
outside temperature	Running	1m	728 Days	2 %	[Action]
room temperature	Running	10m	730 Days	0 %	[Action]
infl. solar radiation	Running	5m	520 Days	0 %	[Action]
influence of wind	Running	2m	208 Days	1 %	[Action]
influence of room tmp	Running	15m	730 Days	0 %	[Action]

At the bottom, a progress bar indicates a 3% current bus load.

## Data query per web browser

The trend data can be downloaded for each channel using a web browser and viewed in a spreadsheet program or text editor. The calendar function permits limiting the trend data to a desired time period within the trend.

Users can access the Web Server either local or remote via the Internet.

## Trend graph

The data for a trend channel can be graphically displayed on the web user interface. The function is available for OZW772... as of version 6.0.

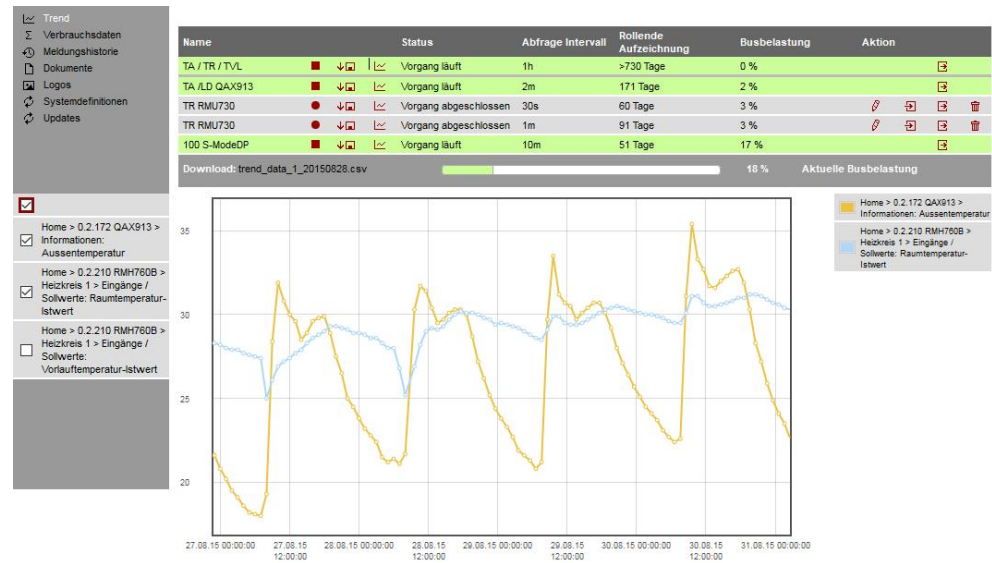

## Data transmission per e-mail

Up to 2 e-mail recipients can be defined for the trend data. Each trend channel can send its data to one or both e-mail recipients. The send interval can be set individually for each trend.

## Import/Export

Trend definitions can be imported to the Web Server or exported from the Web Server.



## Consumption data trending

The "consumption trend" function is available in Web Server OZW772... as of version 3.0. The following devices are supported:

- Synco 700: RMU7x0B, RMH760B, RMK770 (as of version 2.0), RMS705, RMS705B, RMB795, RMB795B
- Synco living: Central apartment unit QAX903, QAX913

OZW772... as of version 5.0

Energy and volume meters that use KNX data points are supported with the integration of KNX S-Mode as of Web Server version 5.0.

The meter is connected directly or via KNX adapter to the KNX bus and transmits its data as per the configuration made in ETS.

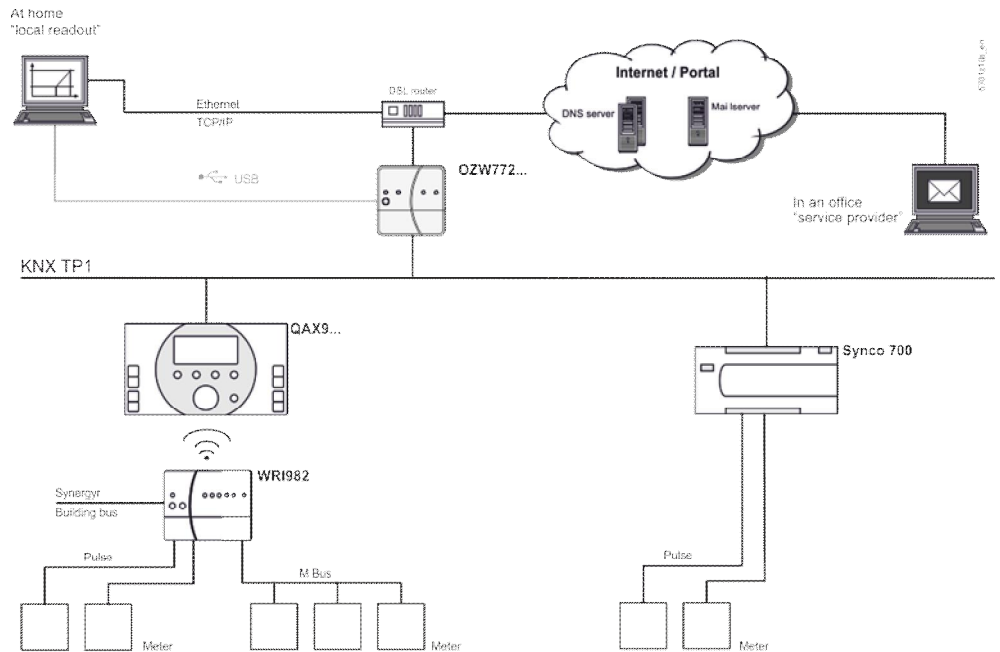

Meter

Current consumption data is saved in the meters (legal requirement).

QAX / Synco 700

- Every 4 hours, central apartment unit QAX9... receives raw data via KNX radio.
- Synco 700 controllers generate the meter data via pulse inputs as per the configured values.

Consumption data can be viewed on individual QAX central units or Synco controllers using the associated menus.

Web Server,  
local or remote

The Web Server offers comfortable access to consumption data:

- Web browser operation users to navigate to the consumption data of the associated devices.
- Easier still: Or a consumption data file can be downloaded from the Web Server. The file contains a list of consumption data for all QAX units (apartment units) and Synco controllers.
- Users can access the Web Server either local or remote via the Internet.

Web Server, e-mail

Consumption data can be sent periodically (set up via Web Server) to max 2 e-mail recipients (e.g. billing company).

**Function**  
**"Energy indicator"**

The "Energy indicator" function is available in Web Server OZW772... as of version 4.0. The following devices are supported:

- Synco 700: RMU7x0B, RMH760B, RMK770 (as of version 2.0), RMS705B, RMB795B
- Synco living: Central apartment unit QAX903, QAX913, QAX910 (as of version 3.0)
- Room controllers: RXB2x, RXL2x, RXB3x, RXL3x
- Room thermostats: RDF301, RDU341, RDGx00KN

The Web Server uses the "Energy indicator" function to read selected data point values from the bus devices and to compare the values to energy-related limit values, or so-called "Green limits".

The data points are also monitored for adherence to the "Green limits". As a result, the "Energy indicator" is displayed in the form of a tree leaf.

**Note**

The "Green limits" are used only together with the "Energy indicator" function. They do **not** represent process or safety limit values which trigger e.g. fault messages or turn off the plant in the event of limit violations.

**Web Server, e-mail**

The "Energy indicator" can send its information periodically (adjustable via Web Server) to a maximum of 2 e-mail recipients.

**Tree leaf as "Energy indicator"**

Green leaf 

"Green leaf" → Green tree leaf, leaf pointing up.

- The "Green leaf" symbol indicates that a data point value has not exceeded its "Green limit", i.e. the value is within a "green" range in terms of energy consumption.

Orange leaf 

"Orange leaf" → Orange tree leaf, leaf pointing down.

- The "Orange leaf" symbol indicates that a data point value has exceeded its "Green limit", i.e. the value is outside a "green" range in terms of energy consumption.

**Standard EN 15232**

The "Energy indicator" function is based on standard EN 15232 "Energy efficiency in buildings".

**Example: "Energy indicator" web page function**

Web page with "Energy indicator" function; example with data points from "Room 1" and open dialog box to set data point value "Comfort heating setpoint" and its "Green limit" (for "Room 1").

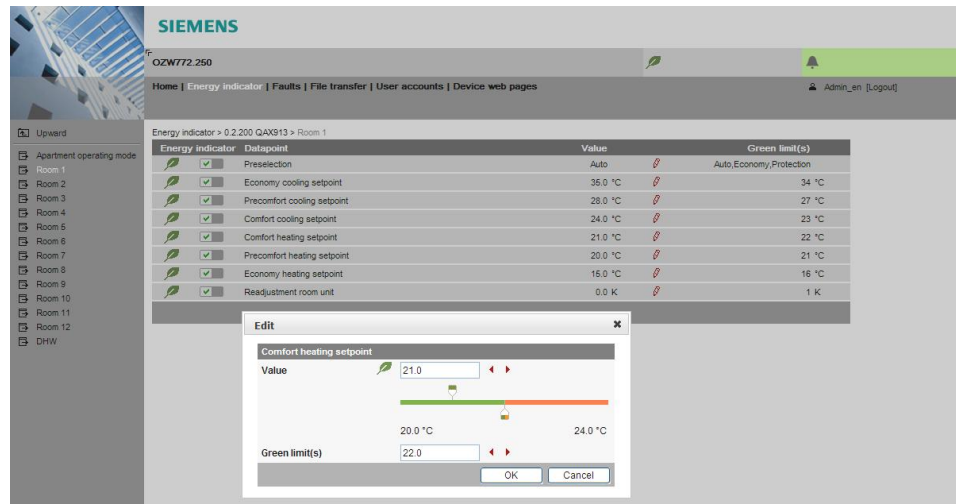

## Web services

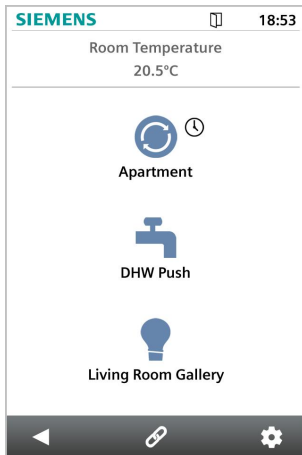

The "Web Application Programming Interface" (Web API) is an interface to provide web services client to the Web Server.

All web API functions are started via "http" or encrypted with "https". Each session starts with authentication at the Web Server.

If "Home Control App" is installed on a smartphone, the app accesses, using the web services, via web API, data points for devices on the KNX network (Communication connection for smartphone, see page 13).

## Type summary

Name		KNX S-Mode	Product number
Web Server	For 1 Synco device	7 data points	OZW772.01
Web Server	For 4 Synco devices	250 data points	OZW772.04
Web Server	For 16 Synco devices	250 data points	OZW772.16
Web Server	For 250 Synco devices	250 data points	OZW772.250

## Ordering and delivery

When ordering, please specify the name and **product number**. Example:

- Web Server **OZW772.16**

The Web Server is delivered in a cardboard box.

The following is included in the package:

- Installation instructions G5701xx (multilingual).
- Package insert with activation key for portal access.
- Power cable, power supply AC 230 V.
- Ethernet cable.
- USB cable.
- 2 cable ties.

## Equipment combinations

The following Synco devices can be connected to the Web Server OZW772...

### Synco range

	Synco devices	Data sheet no.	
Synco 700	Universal controllers	RMU7x0, RMU7x0B	N3144, N3150
	Heating controllers	RMH760, RMH760B	N3131, N3133
	Boiler sequence controllers	RMK770, RMK770 V2	N3132
	Central control units	RMB795, RMB795B	N3121, N3122
	Switching & monitoring units	RMS705, RMS705B	N3123, N3124
	Bus operator unit	RMZ792	N3113
	Room unit	QAW740	N1633
	Central communication unit	OZW771, OZW775	N3117, N5663
Synco RXB/RXL	Room controllers	RXB21.1, RXB22.1	N3873
	Room controllers	RXL21.1, RXL22.1	N3877
	Room controller	RXB24.1	N3874
	Room controller	RXL24.1	N3878
	Room controller	RXB39.1/FC-13	N3875
	Room controller	RXL39.1/FC-13	N3876
Synco RDF/RDD/RDU/RDG	Room thermostat for fan coils	RDF301	N3171
	Room thermostat for fan coils and lighting	RDF301.50	N3171
	Room thermostat for fan coils	RDF600KN	N3171
	Touchscreen thermostat for fan coil	RDF800KN	N3174
	Touchscreen Thermostat for Fan-coil	RDD810KN/NF	N3175
	Room thermostat for VAV	RDU341	N3172
	Room thermostat for fan coils	RDG100KN, RDG160KN, RDG165KN	N3191
	Room thermostat for VAV	RDG400KN	N3192
Synco living	Central apartment unit	QAX903	N2741
	Central apartment unit	QAX910	N2707
	Central apartment unit	QAX913	N2740

### Product documentation

	Document type	Document no.
Web Server OZW772...	Data sheet (this document))	N5701
	Installation instructions (package insert)	G5701
	Commissioning instructions	C5701
	CE declaration of conformity	T5701
	Environmental product declaration	E5701
KNX bus	Data sheet	N3127
	Basic documentation	P3127
ACS790 software	Data sheet	N5649

## Technical design

### Web browser

Devices	Requirements
PC/Laptop (1024 x 786)	Internet Explorer version 10.0 or higher. Firefox version 18.0 or higher.
Smartphone	Specific for device

### Number of browsers

Any number of browsers can be used simultaneously. The maximum data throughput rate is distributed among the browsers. Operation slows down as the number of users increases accordingly.

### Operation, monitoring, alarming

Communication connections for local commissioning (USB) and remote operation, remote monitoring and alarming via Ethernet.

The Web Server is not suited for direct connection to the Internet, but rather must be connected via a firewall. A router typically includes a firewall.

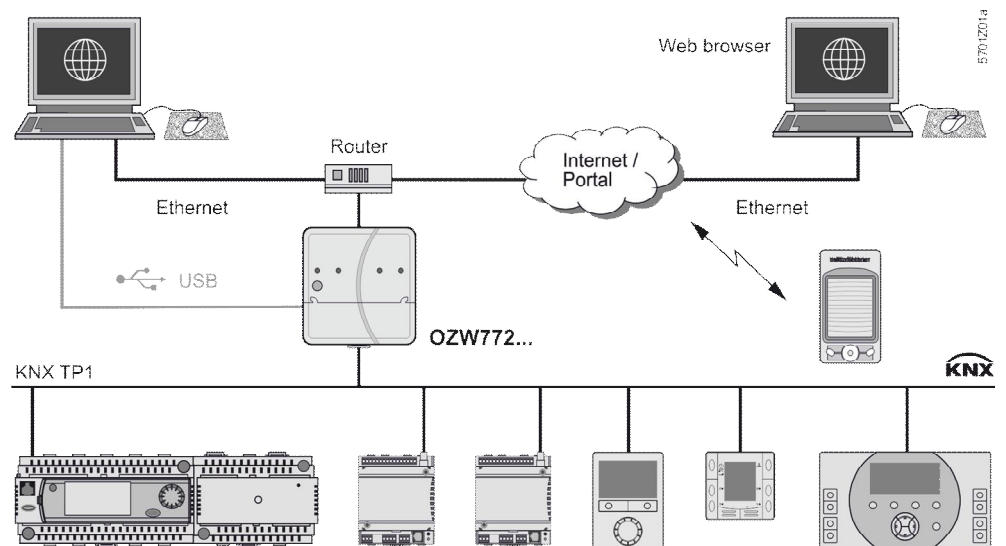

### Interfaces

#### USB

The USB interface directly connects the PC/laptop on site. The required USB cable type A – type Mini-B is delivered with the device.

#### Ethernet

The router/network is connected to the Ethernet RJ45 plug. The Ethernet interface features Auto-MDI(X) for crossed and non-crossed Ethernet cables. An Ethernet category 5 cable is supplied.

#### KNX

The KNX bus is connected to the CE+ and CE- connection terminals labeled "KNX". See data sheet N3127 for more information on the KNX bus.

## Logs

### Web operation

Web operation **via portal** takes place through an HTTPS encrypted connection (Port 443) via TCP/IP. The required certificate is accredited.

Web operation **without portal** takes place through an HTTPS encrypted connection (Port 443) via TCP/IP. The required certificate is not accredited. The self signed certificate by Siemens has saved on the Web Server for a period of 20 years. The certificate can be installed in the web browser as needed.

In addition, an HTTP (Port 80) connection is supported. Port 80 is disabled as delivered. The access via http is not secured. The user is responsible for enabling Port 80.

A RNDIS driver on the PC/laptop is required for USB communication. The RNDIS driver is automatically installed on PC/laptops connected to the Internet (provided the network administrator enables "online update"). The RNDIS driver is also saved to the Web Server under <http://<IP address>/drivers/>.

### Send e-mail

Fault messages, consumption data, energy indicator reports, and trend files are sent in an e-mail via SMTP. The e-mail is encrypted using TLS if supported by the mail server.

### DHCP Client

The Web Server can take its network configuration as client from a DHCP server or be manually configured.

## Execution

### Basic design

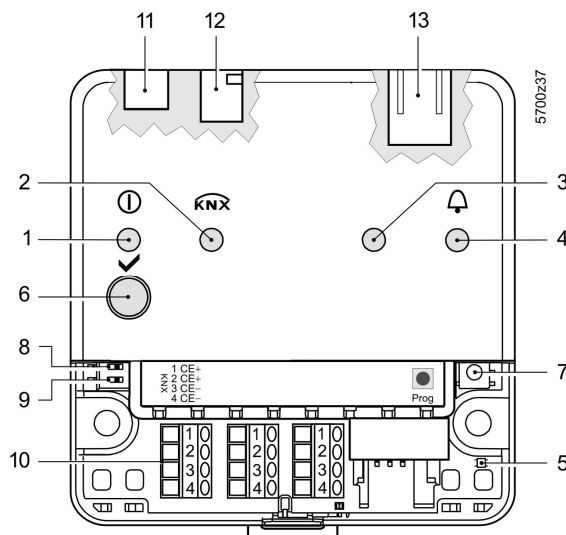

The Web Server consists of a housing lower section containing printed circuit boards with interfaces. The upper housing section covers the printed circuit boards. The upper housing section contains the LED displays and one operating button. The connection terminals and additional display and operating elements are located under the removable cover for the upper housing section. All display and operating elements are labeled.

### Display and operating elements









Pos	Designation
1	LED ⓘ Mode, portal connection display and "Energy indicator"
2	LED <b>KNX</b>
3	LED field bus 2 (reserve)
4	LED fault ⓘ
5	LED addressing mode
6	Remote button ✓
7	Addressing mode button Prog
8	"Message suppression" switch
9	Switch 2 (no function)
10	KNX bus connection terminals
11	Operating voltage connection
12	USB connection Mini-B
13	Ethernet connection, RJ45 plug





## LED indication

- |  |  |  |
|--|--|--|
| 1  (red/green/orange) | <ul style="list-style-type: none"><li>• Dark</li><li>• Steady red</li><li>• Flashing red</li><li>• Steady green</li><li>• Lit orange</li><li>• Flashing green green / orange</li></ul> | <p>No operating voltage DC 24 V</p> <p>Web Server starts operating system.</p> <p>Web Server starts application.</p> <p>Web Server operational, "Energy indicator" = "Green leaf"</p> <p>Web Server operational, "Energy indicator" = "Orange leaf"</p> <p>Web Server operational, connected to the portal (LED 0.8 s on, 0.2 s off)</p> |
| 2  (green)            | <ul style="list-style-type: none"><li>• Dark</li><li>• Lit</li><li>• Flashing</li></ul>  | <p>No bus power.</p> <p>KNX operational.</p> <p>Communication on KNX.</p>  |
| 3 Field bus 2 (reserve)  | <ul style="list-style-type: none"><li>• Dark</li></ul>   | <p>No function.</p>  |
| 4 Fault  (red)        | <ul style="list-style-type: none"><li>• Dark</li><li>• Lit</li><li>• Flashing</li></ul>  | <p>No fault (normal operating state).</p> <p>Acknowledged fault.</p> <p>Unacknowledged fault.</p>  |
| 5 Addressing mode (red)  | <ul style="list-style-type: none"><li>• Dark</li><li>• Lit</li></ul>   | <p>KNX addressing mode off.</p> <p>KNX addressing mode on.</p>   |

## Operating buttons

- |  |  |  |
|--|--|--|
| 6 Remote button   | <ul style="list-style-type: none"><li>• Short (&lt; 2 s)</li><li>• Long (&gt; 6 s)</li></ul> | <p>Acknowledges fault message.</p> <p>Send the system report to the fault e-mail recipient (not to consumption data, and "Energy indicator" and trend data recipient).</p>   |
| 7 Addressing mode   | <ul style="list-style-type: none"><li>• Short (&lt; 2 s)</li></ul>                           | <p>Press once: KNX addressing mode On</p> <p>Press again: KNX addressing mode off.</p>   |
| Button combinations<br> and  | <ul style="list-style-type: none"><li>• Long (&gt; 6 s)</li></ul>                            | <p>Simultaneously press  and  restores default factory settings.</p> <p> All configuration data and settings are reset. The device list, plant diagrams, and unsent messages are deleted. History data is not deleted.</p> |

## Switches

- |   |  |   |
|---|--|---|
| 8  Message suppression | <ul style="list-style-type: none"><li>• Position ON </li><li>• Position OFF </li></ul> | <p>Sending messages is suppressed.</p> <p>Sending messages permitted.</p> |
| 9  DIP switch 2        | <ul style="list-style-type: none"><li>• Switch settings.</li></ul>   | <p>No function.</p>   |

## Notes

---

### Mounting

The Web Server can be mounted in a panel, distribution box, or on a wall. Include space for wiring when planning. Make sure service can easily access the unit and the unit is ventilated properly.

- Standard mounting On standard rail TH 35-7.5.
- Wall mounting Attached with 2 screws.
- Mounting position Horizontal or vertical.
- Mounting and dimensions See "Dimensions".

## Install

Important notes	<p>Observe the following when installing:</p> <ul style="list-style-type: none"><li>• Run fuses, switches and wiring as per local regulations for electrical installations.</li><li>• We do not recommend plant monitoring via USB interface in environments with strong electromagnetic interference (e.g. in industrial environments with electrical welding equipment).</li><li>• See "Technical data" for electromagnetic compatibility.</li></ul>
Operating voltage	<p>The supplied AC 230 V power supply provides the DC 24 V operating voltage for the Web Server.</p>
Wiring	<p>The operating voltage, USB and Ethernet plugs are located on the upper part of the housing.</p> <p>The terminals on the device for the KNX bus are located under the removable cover.</p>
Connection terminals	<p>The connection terminals are designed for wire diameters of min. 0.5 mm or cross-sections of 0.25...1.5 mm<sup>2</sup> or stranded wire cross-sections of 0.25...1.0 mm<sup>2</sup>.</p>

## Commissioning

Connections	<p>Web-Server is commissioned <b>directly via the portal</b> with a PC/Laptop. A web browser required on the PC/Laptop.</p> <p>The Web Server can be commissioned <b>locally via USB or with ACS790</b>. The supplied USB cable type A – Type Mini-B connects the Web Server to the PC/laptop.</p> <p>Additional information is available in the included installation guide G5701 or commissioning guide C5701 at the Download Center at <a href="http://www.siemens.com/ozw772manual">www.siemens.com/ozw772manual</a>.</p> <p>ETS configures and commissions KNX S-Mode devices and is described in the commissioning guide C5701.</p>
Router	<p>A suitable router is required for remote operation via Internet.</p> <p>The router must support NAT/PAT to access via the portal or via a direct connection using a fixed IP address. For a direct connection using a dynamic IP address, it must also support a dynamic DNS server.</p>
IP address	<ul style="list-style-type: none"><li>• The IP address via USB is set: <b>192.168.250.1</b>.</li><li>• Default setting for IP address via Ethernet: <b>192.168.251.1</b>.</li><li>• The network administrator must provide an IP address for the Web Server before you can connect the Web Server via Ethernet to a managed network.</li></ul>



**User groups** User accounts are created and assigned to specific user groups for customized user operation.

End user

- Access to end-user data and fault overview.
- Operate and monitor via menu tree and plant diagrams.
- Administer own user accounts.

Service

Same as end user. In addition:

- Access service data.
- Create, download, and manage trend data
- Download consumption data and message history.
- Upload customized logos and documents.
- System definitions update.
- Update device web pages.

Administrator

Same as service. In addition:

- Edit device list.
- Create device web pages.
- Create, copy, change, and delete plant diagrams.
- Select "Energy indicator" data points, as needed, edit default values for the data points and/or "Green limits".
- Administer all user accounts.

**Maintenance** The OZW772... Web Server is maintenance free (no battery changes, no fuses). Use only a dry towel to clean the housing.

**Repair** The OZW772... Web Server cannot be repaired on site. If faulty, return to the Repair Center at the relevant Regional Company.

## Disposal

---



The device is considered electrical and electronic equipment for disposal in terms of the applicable European Directive and may not be disposed of as domestic garbage.

- Use only proper channels to dispose the device.
- Comply with all local, applicable laws and regulations.

## Technical data

Power cable for Web Server OZW772...	Operating voltage	AC 230 V ±15 %
	Rated voltage "Euro plug"	AC 230 V EN 50075 and VDE 0620-1
	Frequency	50/60 Hz
	Power consumption (including Web Server OZW772...)	3 VA typical
	Protection class	II
	Output voltage	SELV 24 VDC
	Fusing of supply lines	Max. 16 A
	Cable length (distance from AC 230 V plug to Web Server)	Max. 1.6 m
Web Server OZW772...	Operating voltage	SELV 24 VDC ±5%, 625 mA max.
	Power consumption	2 W typical
Function data	Clock reserve	Min. 72 hours
	Device list	
	OZW 772.01	1 Synco device
	OZW 772.04	Up to 4 Synco devices
OZW 772.16	Up to 16 Synco devices	
OZW 772.250	Up to 250 Synco devices	
KNX bus	Interface type	TP1 (twisted pair, 1 cable pair)
	2-wire bus	CE+, CE- (non exchangeable) □
	Bus load number	E 15
	KNX bus power consumption	6 mA.
	Permissible line length and cable types	See data sheet N3127.
	Connection, screw terminals for	
Solid/stranded wire (twisted or with ferrule)	min. Ø 0.5 mm	
1 solid wire per terminal	0.25...1.5 mm <sup>2</sup>	
1 stranded wire per terminal.	0.25...1.0 mm <sup>2</sup>	
USB	Interface type	USB V2.0
	Device class	RNDIS
	Baud rate	Max. 12 Mbps (full speed)
	Connecting cable	
	Cable length	Max. 3 m
Cable type for connection to PC/laptop	USB type A	
Cable type for connection to OZW772...	USB type Mini-B	
Ethernet	Interface type	100BaseTX, IEEE 802.3 compatible
	Bitrate	Max. 100 Mbps
	Protocol	TCP/IP
	Recognition	Auto MDI-X.
	Connection, plug	RJ45 plug (screened) □
Cable type	Standard Cat-5, UTP or STP	
Cable length	Max. 100 m.	
Directives and standards	Product standard	EN 60950-1 Information technology equipment – Safety
	EU conformity (CE)	CE1T5711xx <sup>*)</sup>
	RCM conformity	CE1T5711en_C1 <sup>*)</sup>
	EAC conformity	Eurasia conformity
Environmental compatibility	The product environmental declaration CE1E5711en <sup>*)</sup> contains data on environmentally compatible product design and assessments (RoHS compliance, materials composition, packaging, environmental benefit, disposal).	
Degree of protection	Protective category	IP30 to EN 60529
	Protection class	III as per EN 60950-1

\*) The documents can be ordered at <http://siemens.com/bt/download>.

Degree of protection	Degree of protection	IP30 to EN 60529.
	Protection class	III as per EN 60950-1.
Ambient conditions	Operation	IEC 60721-3-3
	Climatic conditions	Class 3K5
	Temperature (housing with electronics)	0...50 °C
	Humidity	5...95% r. h. (non-condensing)
	Mechanical conditions	Class 3M2
	Transport	IEC 60721-3-2
Climatic conditions	Class 2K3	
Temperature	-25...+70 °C	
Humidity	<95% r.h.	
Mechanical conditions	Class 2M2	
Materials and colors	Upper housing section	PC + ASA, RAL 7035 (light-gray)
	Lower housing section	PC + ASA, RAL 5014 (dove blue).
Dimensions	Length x width x height (max. dimensions)	87.5 mm x 90 mm x 40 mm
Weight	Web Server OZW772...	0.136 kg
	Web Server with packaging, installation instructions, power unit, USB and Ethernet cable, cable straps.	0.589 kg.
	Packaging	Cardboard box
Terms, abbreviations	Auto Medium Dependent Interface - Crossed	Auto-MDI(X)
	Dynamic Domain Name System	Dynamic DNS
	Dynamic Host Configuration Protocol	DHCP
	Energy Cost Allocation	ECA
	Engineering Tool Software	ETS
	HVAC Integrated Tool von Siemens	HIT
	Hyper Text Transfer Protocol	HTTP
	Hyper Text Transfer Protocol Secure	HTTPS
	Internet Protocol	IP
	KNX System installation methods	KNX S-Mode
	Konnex	KNX
	Network Address Translation	NAT
	Port and Address Translation	PAT
	Remote Network Driver Interface Specification	RNDIS
	Simple Mail Transfer Protocol	SMTP
	Shielded Twisted Pair	STP
	Transport Layer Security	TLS
	Transmission Control Protocol	TCP
	Universal Serial Bus	USB
	Unshielded Twisted Pair	UTP
	Web Application Programming Interface	Web API

**Connection diagrams**

**Connection diagram**

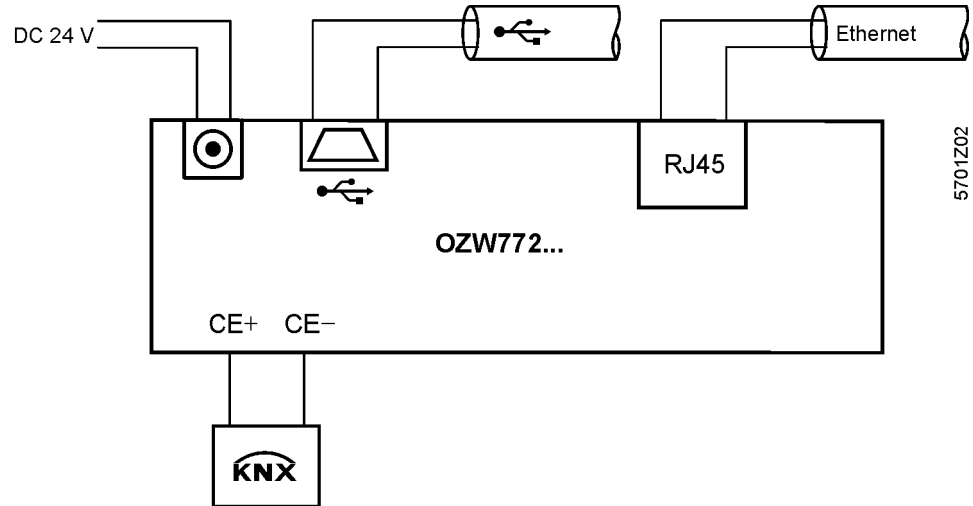

**KNX connection terminals**

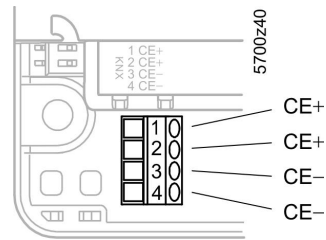

**Pin assignment**

DC 24 V plug

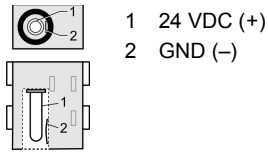

**Dimensions**

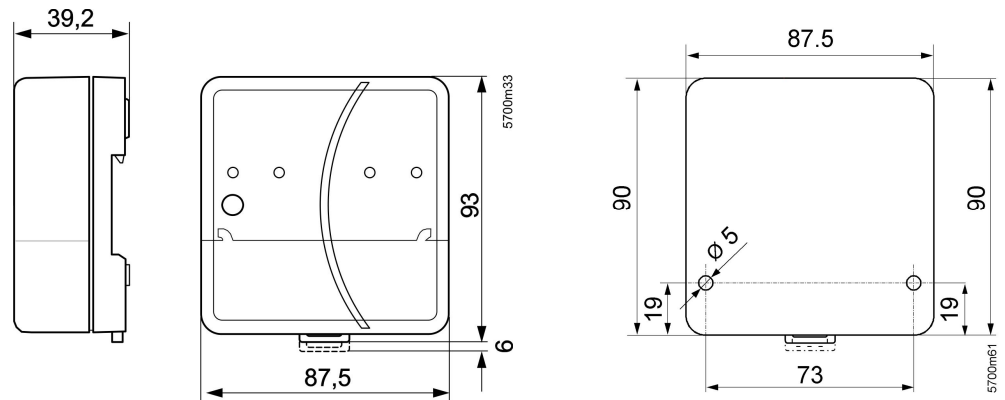

Published by:  
 Siemens Switzerland Ltd.  
 Building Technologies Division  
 International Headquarters  
 Gubelstrasse 22  
 6301 Zug  
 Switzerland  
 Tel. +41 58-724 24 24  
[www.siemens.com/buildingtechnologies](http://www.siemens.com/buildingtechnologies)

© Siemens Switzerland Ltd 2009  
 Delivery and technical specifications subject to change