

OpenAir™

Air damper actuators

GDB..1E





Electronic motor driven actuators for open-close, three-position and modulating control

- Nominal torque 5 Nm
- Operating voltage AC 24 V ~ / DC 24...48 V = or AC 100...240 V ~
- Mechanically adjustable span between 0...90°
- Pre-wired with 0.9 m long connection cables
- Type-specific variations with adjustable offset and span for the positioning signal
- Position indication: mechanical and electrical
- Feedback potentiometer
- Self-adaption of rotational angle range and adjustable auxiliary switches for supplementary functions

The rotary actuators are used in ventilation and air conditioning plants to regulate and shut off air dampers:

- For damper areas up to 0.8 m² (guideline, always observe damper manufacturer's data).
- Suitable for use with modulating controllers (DC 0/2...10 V), open-close or three-position controllers for air dampers or air throttles.
- We recommend a minimum pulse length of 500 ms on rotary actuators operated with 3-point control to ensure continuous and accurate operation.

Functions

GDB..	AC 24 V ~ / DC 24...48 V =	141.1E / 142.1E / 146.1E	161.1E / 163.1E / 164.1E / 166.1E
	AC 100...240 V ~	341.1E / 346.1E	361.1E
Control type	Open-close / three-position		Modulating control (0/2...10 V)
Rotary direction	<p>Clockwise or counter-clockwise direction depends ...</p> <p>... on the type of control</p> <p>... on the setting of the rotary direction switch.</p> <div style="display: flex; justify-content: space-around;"> <div style="text-align: center;">  <p>CW</p> </div> <div style="text-align: center;">  <p>CCW</p> </div> </div> <p>With no power applied, the actuator remains in the respective position.</p>		
Position indication: Mechanical	Rotary angle position indication by using a position indicator.		
Position indication: Electrical	The feedback potentiometer can be connected to external voltage to indicate the position.	Output voltage U = DC 0/2...10 V is generated proportional to the rotary angle. U depends on the rotary direction of the DIL switch setting.	
Auxiliary switch	The switching points for auxiliary switches A and B can be set independent of each other in increments of 5° within 0° to 90°.		
Self-adaptation of linear span	When self-adaptation is active, the actuator automatically determines the mechanical end positions of the linear span and maps the characteristic function (U ₀ , ΔU) to the calculated linear span.		
Manual adjustment	The actuator can be manually adjusted by pressing the gear train disengagement button.		
Rotary angle limitation	The rotary angle of the shaft adapter can be limited mechanically with a set screw.		

Technical design

Housing

The housing consists essentially of flame retardant, non brominated, non chlorinated glass fibre reinforced plastic.

Actuator motor / Gears

- Brushless, robust DC motors ensure reliable operation regardless of load. The damper actuators do not require an end position switch, are overload proof, and remain in place upon reaching the end stop.
- The gears are maintenance free and low noise.

Type summary

Type	Stock no.	Control	Operating voltage	Positioning signal Y	Position indicator U = DC 0...10 V ==	Feedback potentiometer 5 kΩ	Self-adaption of rotational angle range	Aux. switches	Rotary direction switch	
GDB141.1E	S55499-D377	Open-close or three-position	AC 24 V ~ / DC 24...48 V ==	-	-	-	-	-	yes	
GDB142.1E	S55499-D378					yes		-		
GDB146.1E	S55499-D379		AC 100...240 V ~			-		-		2
GDB341.1E	S55499-D380					-		-		
GDB346.1E	S55499-D381					2				
GDB161.1E	S55499-D393	Modulating	AC 24 V ~ / DC 24...48 V ==	DC 0/2...10 V ==	yes	-	yes	-	yes	
GDB163.1E	S55499-D394			DC 0...35 V ==	yes	yes				
GDB164.1E	S55499-D395			DC 0...35 V ==	yes	-	yes	2		
GDB166.1E	S55499-D396			DC 0/2...10 V ==	yes	yes				
GDB361.1E	S55499-D382		AC 100...240 V ~	DC 0/2...10 V ==	yes	yes	-			

Nominal torque: 5 Nm (applies to all GDB..1E actuators)

Accessories

See data sheet N4698

Product documentation

Topic	Title	Document ID
Data sheet	Air damper actuators	A6V10636149_enAP_c
Technical basics	Rotary damper actuators without spring return GD..E	A6V10636139_en--_a
Mounting instructions	GDB..1E, GLB..1E	A6V10636143_----_a

Related documents such as environmental declarations, CE declarations, etc., can be downloaded at the following Internet address:

<http://siemens.com/bt/download>

Notes

Safety

	<p>⚠ Caution</p>
	<p>National safety regulations</p> <p>Failure to comply with national safety regulations may result in personal injury and property damage.</p> <ul style="list-style-type: none"> • Observe national provisions and comply with the appropriate safety regulations. • Use only properly trained technicians for mounting, commissioning, and servicing.

Potentiometer and auxiliary switches

Potentiometer and auxiliary switches cannot be added in the field

Installation

	<p>⚠ WARNING</p>
	<p>No internal line protection for supply lines to external consumers Risk of fire and injury due to short-circuits</p> <ul style="list-style-type: none"> • Adapt the line diameters as per local regulations to the rated value of the installed fuse.

Maintenance

The actuators GDB..1E are maintenance-free.

Disposal

	<p>The device is considered an electronics device for disposal in terms of European Directive 2012/19/EU and may not be disposed of as domestic garbage.</p>
	<ul style="list-style-type: none"> • Dispose of the device through channels provided for this purpose. • Comply with all local and currently applicable laws and regulations..

Technical data

Power supply (GDB1..1E)		
Operating voltage (SELV/PELV) / Frequency		AC 24 V ~ ±20 % (19.2...28.8 V ~) / 50/60 Hz DC 24...48 V = ±20 % (19.2...57.6 V =) ¹⁾
Power consumption running	GDB14..1E, GDB16..1E	2 VA / 1 W 2.1 VA / 1.2 W
Power consumption holding	GDB14..1E, GDB16..1E	0.5 W 0.7 W
Power supply (GDB3..1E)		
Operating voltage / Frequency		AC 100...240 V ~ ±10 % (90...264 V ~) / 50/60 Hz
Power consumption running	GDB34..1E, GDB36..1E	5 VA / 1.6 W 3.3 VA / 1.2 W
Power consumption holding	GDB34..1E, GDB36..1E	0.9 W 0.5 W
Function data		
Nominal torque		5 Nm
Maximum torque (blocked)		10 Nm
Minimum holding torque		5 Nm
Nominal rotary angle (with position indication)		90°
Maximum rotary angle (mechanic limitation)		95° ± 2°
Runtime for 90° rotary angle		150 s
Actuator sound power level		28 dB(A)

¹⁾ C-UL: Permitted only to DC 30 V =

Inputs		
Positioning signal for GDB14..1E Operating voltage (wires 1-6/G-Y1) AC 24 V ~ / DC 24...48 V = (wires 1-7/G-Y2)		clockwise counterclockwise
Positioning signal for GDB34..1E Operating voltage (wires 4-6/N-Y1) AC 100...240 V ~ (wires 4-7/N-Y2)		clockwise counterclockwise
Positioning signal for GDB16..1.E Input voltage (wires 8-2/Y-G0) Current consumption Input resistance		DC 0/2...10 V = 0.1 mA >100 k Ω
Max. permissible input voltage Protected against faulty wiring		DC 35 V = limited to DC 10 V = max. AC 24 V ~ / DC 24...48 V =
Hysteresis for non-adjustable characteristic function for adjustable characteristic function		60 mV 0.6 % of ΔU
Adjustable characteristic function (GDB163.1E, GDB164.1E) Adjustable with 2 potentiometers: Offset U _o Span ΔU		DC 0...5 V = DC 2...30 V = DC 35 V =
Max. input voltage Protected against faulty wiring		max. AC 24 V ~ / DC 24...48 V =

Outputs		
Position indicator Output signal (GDB16..1E) (wires 9-2/U-G0) Output signal (GDB36..1E) (wires 9-2/U-G-) Output voltage U Max. output current Protected against faulty wiring		DC 0...10 V = DC ± 1 mA max. AC 24 V ~ / DC 24...48 V =
Aux. power supply (G- / G+) GDB36..		DC 24 V = ± 20 %, max. 10 mA
Feedback potentiometer (for GDB142.1E) Change of resistance (wires P1-P2) Load Max. sliding contact current Permissible voltage at potentiometer (SELV/PELV) Insulation resistance between potentiometer and housing		0...5000 Ω <0.25 W <10 mA AC 24 V ~ / DC 24...48 V = AC 500 V ~

Auxiliary switches (GDB146.1E, GDB166.1E, GDB346.1E)		
Switching voltage Contact rating		AC 24...250 V ~ / DC 12...30 V = 6 A resistive, 2 A inductive, min. 10 mA @ AC 4 A resistive, 2 A inductive, min. 10 mA @ DC 30 V = 0.8 A res., 0.5 A inductive, min. 10 mA @ DC 60 V =
Electric strength auxiliary switch against housing Switching range for auxiliary switches / setting increments		AC 4 kV 5°...90° / 5°
Factory switch setting: Switch A Switch B		5° 85°

Connection cables	
Cable length	0.9 m
Cross section of prewired connection cables	0.75 mm ²
Permissible length for signal lines	300 m

Degree of protection	
Insulation class AC 24 V ~ / DC 24...48 V =, feedback potentiometer AC 100...240 V ~, auxiliary switches	As per EN 60730 III II
Housing protection	IP 54 as per EN 60529

Environmental conditions	
Operation Climatic conditions Mounting location Temperature extended Humidity (non-condensing)	IEC 60721-3-3 Class 3K5 interior, weather-protected -32...+55 °C <95 % r.F.
Transport Climatic conditions Temperature extended Humidity (non-condensing)	IEC 60721-3-2 Class 2K3 -32...+70 °C <95 % r.F.
Storage Climatic conditions Temperature extended Humidity (non-condensing)	IEC 60721-3-1 Class 1K3 -32...+50 °C <95 % r.F.
Mechanical conditions	Class 2M2

Standards, directives and approvals	
Product standard	EN 60730 Part 2-14 / Particular requirements for electric actuators
Electromagnetic compatibility (Applications)	For use in residential, commercial, light-industrial and industrial environments
EU Conformity (CE)	A5W00003842 ²⁾
RCM Conformity	A5W00003843 ²⁾
EAC Conformity	Eurasian conformity
UL	UL as per UL 60730 http://ul.com/database cUL as per CSA-C22.2 No. 24-93

Environmental compatibility
The product environmental declaration A5W00026066 ²⁾ contains data on environmentally compatible product design and assessments (RoHS compliance, materials composition, packaging, environmental benefit, disposal).

Dimensions	
Actuator W x H x D	see „Dimensions“, p. 9
Damper shaft round round Square Min. shaft length Shaft hardness	8...16 mm 8...10 mm (with centering element) 6...12.8 mm 20 mm <300 HV

Weight	
Without packaging	Max. 0.49 kg, without switches Max. 0.63 kg, with switches

²⁾ The documents can be downloaded from <http://siemens.com/bt/download>.

Internal Diagrams

GDB14..1E (open-close, three-p.)

GDB34..1E (open-close, three-p.)

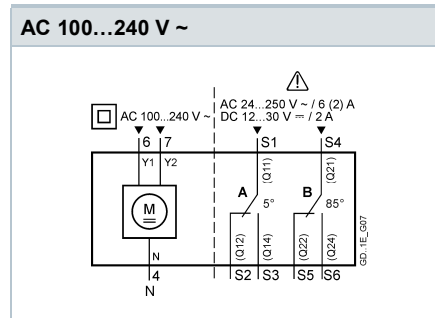
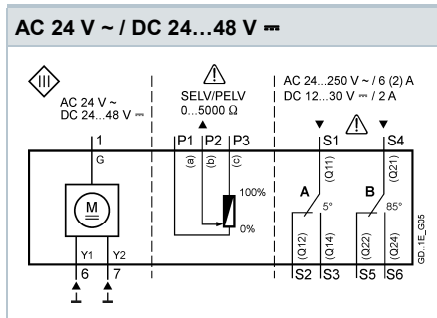

GDB16..1E (modulating, Y= DC 0/2...10 V ~)

GDB16..1E (modulating, Y= DC 0...35 V ~)

GDB361.1E (modulating control)

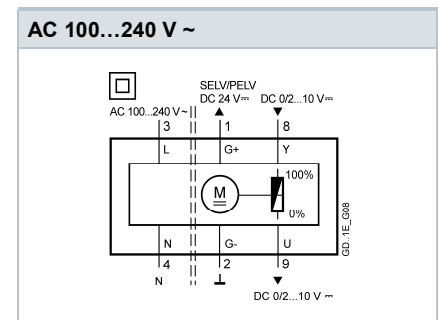
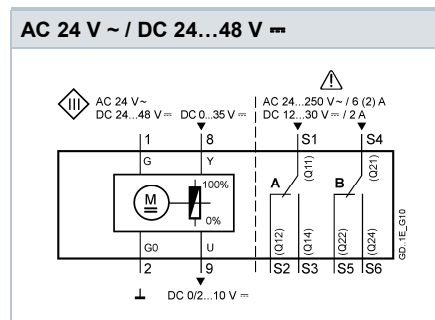
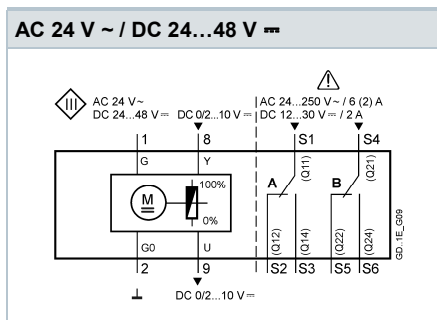

Connection diagrams

GDB1..1E (AC 24 V ~ / DC 24...48 V ~)

Open-close, single wire control Single Pole Single Throw (SPST)	Open-close, two wire control Single Pole Double Throw (SPDT)	Three-position control	Modulating control

GDB3..1E (AC 100...240 V ~)

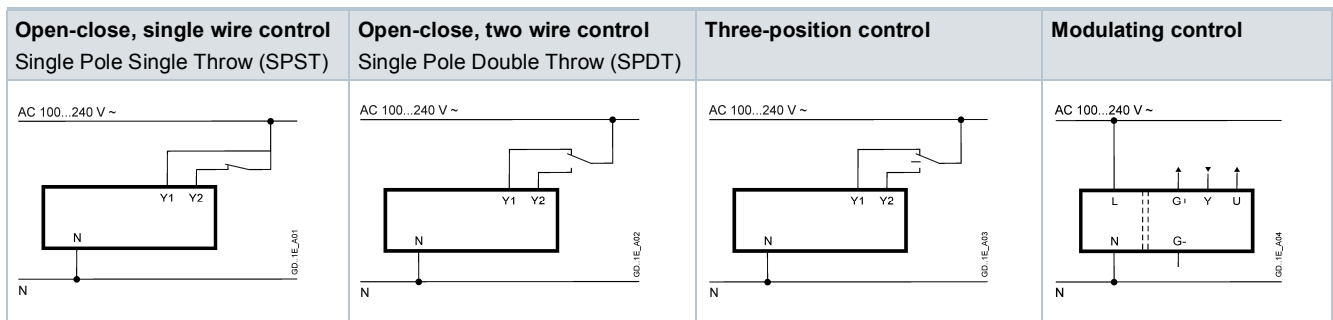

Cable labeling

Connection	Code	No	Color	Abbreviation	Meaning
Actuators	G	1	red	RD	System potential AC 24 V ~ / DC 24...48 V =
AC 24 V ~	G0	2	black	BK	System neutral
DC 24...48 V =	Y1	6	purple	VT	Positioning signal AC/DC 0 V, "clockwise" (GDB14..1E)
	Y2	7	orange	OG	Positioning signal AC/DC 0 V, "counter-clockwise" (GDB14..1E)
	Y	8	grey	GY	Signal in (GDB16..1E)
	U	9	pink	PK	Signal out (GDB16..1E)
Actuators	L	3	brown	BR	Line AC 100...240 V ~
AC 100...240 V ~	N	4	light blue	BU	Neutral conductor
	Y1	6	black	BK	Positioning signal AC 100...240 V ~, "clockwise" (GDB34..1E)
	Y2	7	white	WH	Positioning signal AC 100...240 V ~, "counter-clockwise" (GDB34..1E)
	G+	1	red	RD	System potential DC 24 V = (aux. power supply) (GDB361.1E)
	G-	2	black	BK	System neutral (aux. power supply) (GDB361.1E)
	Y	8	grey	GY	Signal in (GDB361.1E)
	U	9	pink	PK	Signal out (GDB361.1E)
Feedback potentiometer	a	P1	white/red	WH RD	Potentiometer 0...100 % (P1-P2)
	b	P2	white/blue	WH BU	Potentiometer pick-off
	c	P3	white/pink	WH PK	Potentiometer 100...0 % (P3-P2)
Auxiliary switch	Q11	S1	grey/red	GY RD	Switch A input
	Q12	S2	grey/blue	GY BU	Switch A normally closed contact
	Q14	S3	grey/pink	GY PK	Switch A normally open contact
	Q21	S4	black/red	BK RD	Switch B input
	Q22	S5	black/blue	BK BU	Switch B normally closed contact
	Q24	S6	black/pink	BK PK	Switch B normally open contact

Dimensions

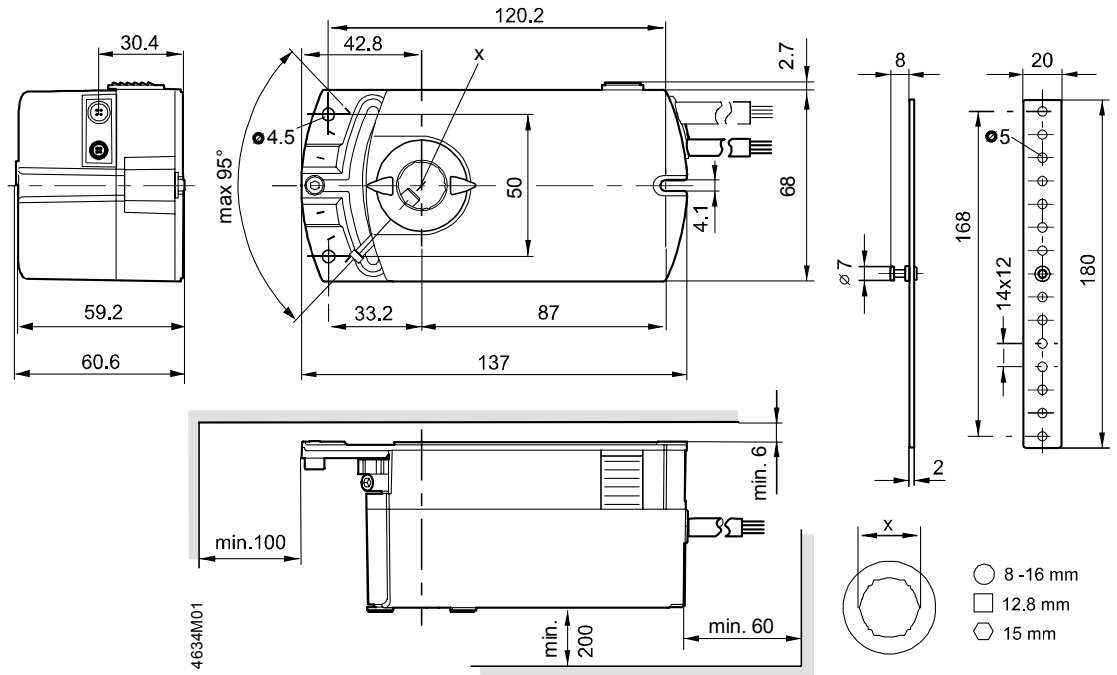

Dimensions in mm

Revision numbers

Type	Valid from rev. no.	Type	Valid from rev. no.
GDB141.1E	..C	GDB164.1E	..A
GDB142.1E	..C	GDB166.1E	..C
GDB146.1E	..C	GDB361.1E	..C
GDB161.1E	..C	GDB341.1E	..C
GDB163.1E	..A	GDB346.1E	..C

Issued by
Siemens Switzerland Ltd
Building Technologies Division
International Headquarters
Gubelstrasse 22
6301 Zug
Switzerland
Tel. +41 41-724 24 24
www.siemens.com/buildingtechnologies

© Siemens Switzerland Ltd, 2016-2018
Technical specifications and availability subject to change without notice.

Document ID A6V10636149_enAP_c
Issue 2018-01-25